



Meridian 218  
Zone Controller  
User Guide

**MERIDIAN**

## Important safety instructions

- Read the instructions.
- Keep these instructions.
- Follow all instructions.
- Do not use this apparatus near water.
- Clean only with a dry cloth.
- Install only in accordance with the manufacturer's instructions.
- Refer all servicing to approved service personnel.

**WARNING: TO REDUCE THE RISK OF FIRE OR ELECTRIC SHOCK, DO NOT EXPOSE THIS APPARATUS TO RAIN OR MOISTURE.**

This apparatus has been designed with Class 1 construction and must be connected to a mains socket outlet with a protective earthing connection (the third grounding pin).

This apparatus does not include a power switch. The apparatus may be isolated from mains power either by unplugging the power connector from the rear of the unit, or by unplugging the connector at the opposing end of the power cord or cable from its supply outlet. As a result, either or both of these connectors should remain accessible.

### Safety warnings



**WARNING!**  
**RISK OF ELECTRIC SHOCK – DO NOT OPEN**  
**ATTENTION!**



**NE PAS OUVRIR – RISQUE DE DÉCHARGE ÉLECTRIQUE**

**Caution:** to reduce the risk of electric shock, do not remove cover. No user serviceable parts inside. Refer servicing to qualified service personnel.



The lightning flash with arrowhead symbol, within an equilateral triangle, is intended to alert the user to the presence of uninsulated “dangerous voltage” within the product’s enclosure that may be of sufficient magnitude to constitute a risk of electric shock to persons.



The exclamation point within an equilateral triangle is intended to alert the user to the presence of important operating and maintenance (servicing) instructions in the literature accompanying the appliance.

## Climate

The equipment has been designed for use in moderate climates and in domestic situations.



Only use at an altitude not exceeding 2000m.

## Safety warnings

- Do not expose the unit to dripping or splashing.
- Do not place any object filled with liquid, such as a vase, on the unit.
- Do not place naked flame sources, such as lighted candles, on the unit.

## To avoid overheating

- Do not position the product in direct sunlight.
- Do not position the product near heat sources, such as a radiator.
- Do not position the product on a soft surface such as a carpet.
- Leave at least 10cm around the product to ensure sufficient ventilation.

## To avoid interference

- Do not position the unit near strong electrical or magnetic radiation, such as near a power amplifier.

## Radio interference

**FCC Warning:** This equipment generates and can radiate radio frequency energy and if not installed and used correctly in accordance with our instructions may cause interference to radio communications or radio and television reception. It has been type-tested and complies with the limits set out in Subpart J, Part 15 of FCC rules for a Class B computing device. These limits are intended to provide reasonable protection against such interference in home installations.



EEC: This product has been designed and type-tested to comply with the limits set out in EN55032:2015 and EN55024:2010 + A1:2015.

## Copyright and acknowledgements

### **Sales and service in the UK**

Meridian Audio Ltd, Latham Road, Huntingdon,  
Cambridgeshire, PE29 6YE, England.

Tel (01480) 445678  
Fax (01480) 445686

### **Designed and manufactured in the UK**

Meridian Audio Ltd, Latham Road, Huntingdon,  
Cambridgeshire, PE29 6YE, England.

### **Visit us on the Web**

[www.meridian-audio.com](http://www.meridian-audio.com)

Copyright © 2017 Meridian Audio Ltd.

Part no: P88452

**MHR:** this product incorporates copyright protection technology covered by certain patent applications and intellectual property of Meridian Audio Ltd. This technology is provided for the express purpose of securely containing copyright audio within the Meridian System only. Reverse engineering or circumvention of this protection is strictly prohibited.

MQA decoding technology is used under licence from MQA Ltd.

Boothroyd|Stuart Meridian, Meridian, and Sooloos are registered trademarks of Meridian Audio Ltd.

This guide was produced by:  
Human-Computer Interface Ltd, [www.interface.co.uk](http://www.interface.co.uk)

### **Product registration**

Register your Meridian 218 Zone Controller at:

[www.meridian-audio.com](http://www.meridian-audio.com)

# Contents

Introduction	1
Specifications	3
Unpacking	5
Applications	7
Configuring the 218 Zone Controller	15
Controlling the 218 Zone Controller	21
Index	23



## Introduction

The Meridian 218 is a compact, networked, Zone Controller designed to integrate Meridian DSP loudspeakers into an automated home audio system. It has analogue and digital stereo inputs as well as a Sooloos audio endpoint in order to meet the needs of a wide range of connectivity and installation requirements.

### Outputs

The 218 Zone Controller provides two Meridian SpeakerLink connectors for simple, straightforward connection to Meridian DSP loudspeakers via standard Cat 5 cable. It also has a pair of unbalanced analogue outputs that can be used to drive a stereo power amplifier and passive loudspeakers. An auxiliary digital output allows you to daisy-chain the output of one zone to the digital input of another.

### Inputs

The 218 provides a range of audio input connections to cater for a range of installation requirements. These include a digital (co-ax/RCA) S/PDIF input, an optical (TOSLINK) input, and a Meridian SpeakerLink input, as well as an unbalanced analogue input.

The 218 also provides a network socket to connect to a Meridian Sooloos System, Meridian's music management platform.

### Audio processing

The 218 Zone Controller features high-quality audio processing. The digital inputs accept signals up to 192kHz, and the analogue inputs are converted to digital at 96kHz sampling. High resolution files may also be replayed from a Meridian Sooloos system.

Signals are processed with Meridian's exclusive apodising filter that ensures maximum audio quality with outputs at 96kHz/24 bit (digital) or 192kHz/24 bit (analogue).

The 218 Zone Controller will also decode MQA (Master Quality Authenticated) audio streams. It can extract the finest of details from music and deliver the audio for rendering either to its own analogue outputs, or to an attached DSP loudspeaker system. The front panel will indicate MQA as will any attached DSP loudspeaker system that can recognise the stream.

When used with analogue loudspeakers the 218 Zone Controller can be configured to provide tone adjustments as well as balance and volume controls, for use with power amplifiers or active analogue speakers. Alternatively it can be configured for fixed output, for connection to an external analogue preamplifier.

## 2 Meridian 218 Zone Controller *User Guide*

When used with Meridian DSP Speakers, the 218 Zone Controller provides control of additional audio processing in the speakers, such as treble and bass tone controls and enhanced room boundary equalisation.

### **System integration**

The 218 Zone Controller is designed to be both configured and controlled via its Ethernet socket.

The 218 can be configured simply by entering the product's IP address into a standard web browser; this then gives access to the range of setup and operational options.

The 218 is controlled using the Automation Protocol, which allows full control of all the runtime settings of the unit, including source selection, volume and audio menus.

The Trigger output is provided for direct control of external devices, for example enabling a power amplifier.



# Specifications

## Audio outputs

- 2-channel unbalanced analogue output, driven by a 192kHz digital to analogue converter.
- 2-channel digital coax output (RCA).
- Two 2-channel Meridian SpeakerLink outputs.
- Optional MHR encryption on digital outputs.

## Audio inputs

- One 2-channel unbalanced analogue input with adjustable sensitivity.
- One 2-channel digital coax input (RCA), 44.1kHz to 192kHz and up to 24-bit precision.
- One 2-channel Meridian SpeakerLink input, 44.1kHz to 192kHz and up to 24-bit precision.
- One 2-channel digital optical (Toslink), 44.1kHz to 96kHz and up to 24-bit precision.
- One network input for connecting to a Meridian Sooloos System and IP control systems.

## Control signals

- One 12VDC/100mA trigger output configurable by source.
- One IR input, compatible with the Meridian G12 remote IR sensor.

## Signal processing

The 218 uses Meridian's proprietary DSP software to provide the following powerful features:

- Apodising filter.
- Upsampling.
- FIFO and error correction.
- Resolution enhancement.
- MQA decoding and rendering.

## Indicators

- Front panel indicators for source selection, standby state, and MQA status.
- Rear panel indicator for power.

## 4 Meridian 218 Zone Controller *User Guide*

# Unpacking

The 218 Zone Controller is supplied with:

- A power cord.
- Four self-adhesive feet.
- This guide

Please contact your retailer if the power cord has the wrong plug for your territory.

The feet can be fixed to the base of the product, which is

printed with circles as a guide. The feet will not be needed if you are mounting the unit on a rack tray. The rack tray is supplied with the screws required to mount the 218; see *Installing 218 Zone Controllers in a rack tray*, page 14.

## Back panel

The following diagram gives details of the back panel connections:

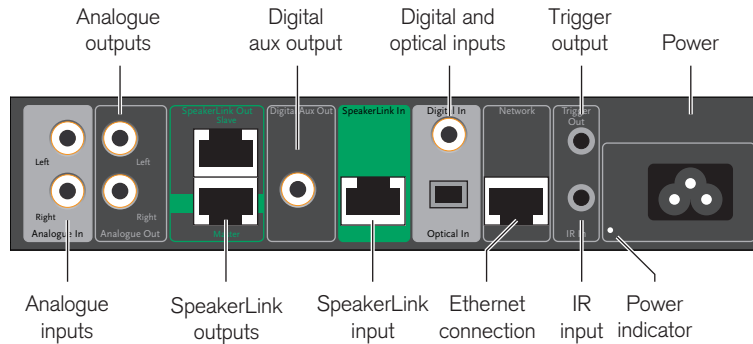

## 6 Meridian 218 Zone Controller *User Guide*

### Front-panel indicators

The currently selected source is indicated by one of five white indicators on the front panel.

In standby the leftmost indicator shows blue.

The rightmost indicator shows the MQA status: green (MQA) or blue (MQA studio).

### Audio inputs

Use this input	To connect to this
Analogue in (Radio, Tape)	The analogue outputs of a source, such as a radio or tape deck.
Digital In (CD, USB)	The digital output of a source such as a CD player.
SpeakerLink In (DVD, Disc)	The SpeakerLink output of a Meridian source, using a Meridian SpeakerLink lead.
Optical In (TV, Cable, Sat, PVR, Game)	The optical output of a source such as a satellite receiver.
Network (SLS)	A Meridian Sooloos System.

The default source assignments are shown after the input name in the table above.

### Audio outputs

Use this output	To connect to this
Analogue Out	The unbalanced analogue inputs of a preamplifier, or a power amplifier such as the G57, using analogue phono leads.
Digital Aux Out	The digital input of another 218 or a Distributor 1, using a 75Ω digital cable.
SpeakerLink	DSP Loudspeakers with Meridian SpeakerLink connectors, using SpeakerLink leads. Use the lower socket for the Master speaker (Note the extra green band).

### Communications connections

Use this connection	To connect to this
Trigger Out	Equipment to be enabled by a DC signal, such as a power amplifier.
IR In	A Meridian infra-red eye.

# Applications

## Minimal system

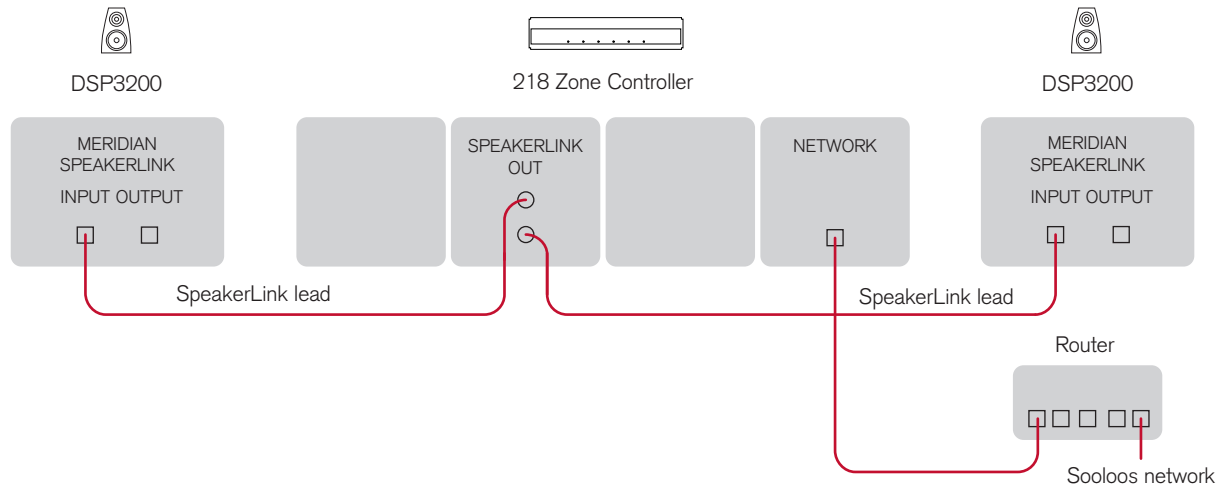

This is a simple, standalone system replaying audio from a Sooloos system, using the Sooloos UI to control the volume.

- Connect the SpeakerLink outputs to the DSP3200s using an RJ45 cables.
- Connect the 218 to the LAN using another RJ45 cable.

- Select the zone in the Sooloos UI and play music in the usual way.

Volume, mute and standby will be controlled from the Sooloos UI.

To add further functionality download the Meridian App for the iPad, which allows control of all the 218 features; see *Controlling the 218 Zone Controller*, page 21.

## 8 Meridian 218 Zone Controller *User Guide*

### Audio-visual system

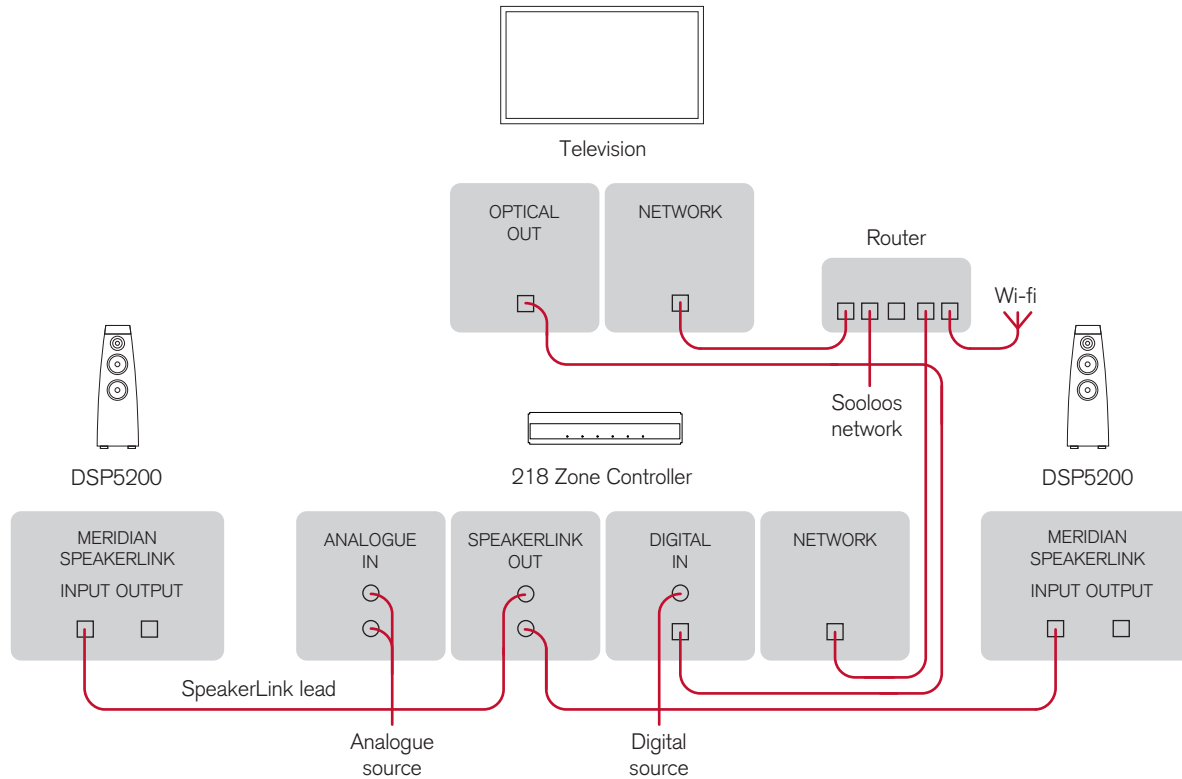

This is a larger system with local sources and more control options.

- Connect the Master SpeakerLink Out socket to the DSP5200 configured as Master using an RJ45 cable.
- Connect the other DSP5200 to the Slave SpeakerLink Out socket.
- Connect the TV to the Optical input socket.
- Connect the 218 to the LAN using an RJ45 cable.
- Optionally connect an analogue source using 50Ω RCA cables, and/or a digital source using a 75Ω RCA cable.

The system can be controlled via the Soolos UI, the (optional) MSR+, or the Automation Interface, using the Meridian App for the iPad; see *Controlling the 218 Zone Controller*, page 21.

# 10 Meridian 218 Zone Controller *User Guide*

## Distributed zone

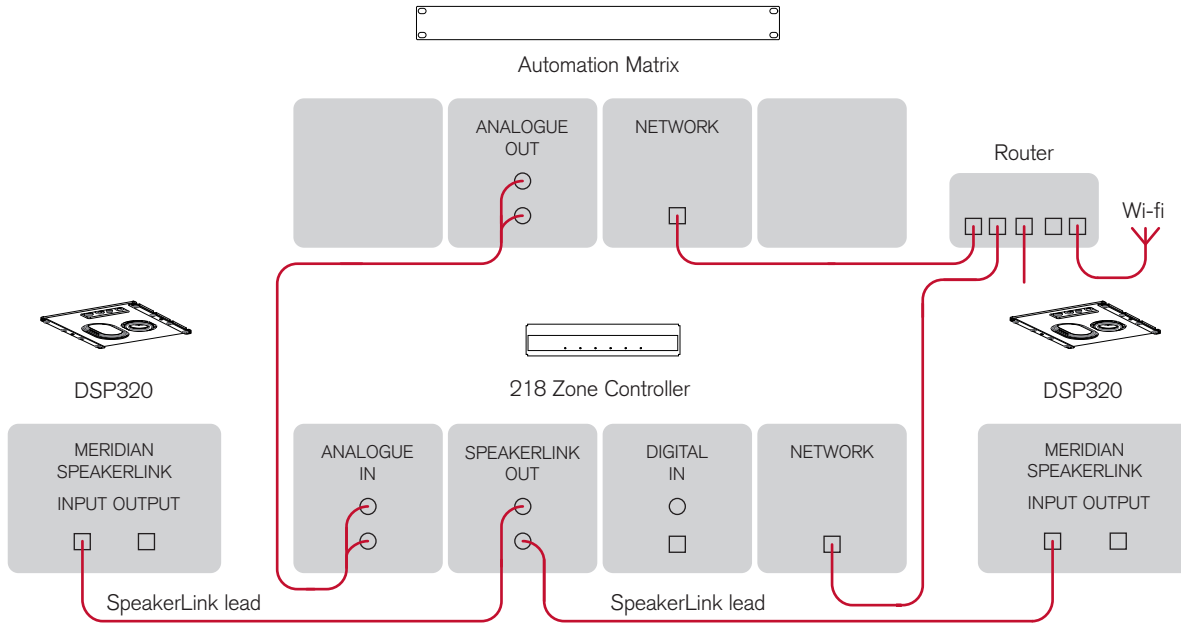



This layout is intended to play back audio in a single zone as part of a larger, whole-house, automation system. The 218 is located in a central rack along with the automation system's audio matrix.

- Connect the Master SpeakerLink output to one of the cables connecting to a DSP320 in-wall loudspeaker.
- Connect the Slave SpeakerLink output to the other DSP320.
- Connect the audio matrix to the 218 analogue input using phono leads.
- Connect the 218 to the LAN using an RJ45 cable.

The system can be controlled using a remote control for the automation system; it will have access to the 218's Automation Interface. The controls that are presented to the user will depend on the UI chosen by the installer.

## 12 Meridian 218 Zone Controller *User Guide*

### Analogue system

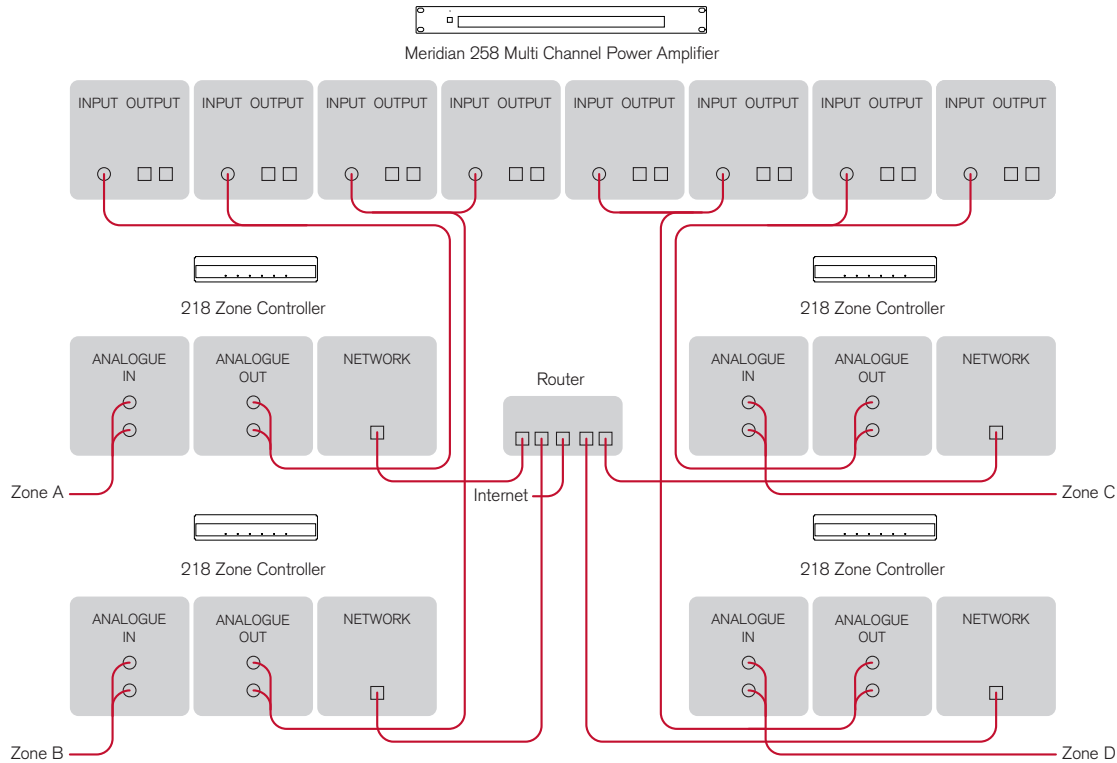

In this system multiple zones are each controlled by a separate 218, using a 258 Multi Channel Power Amplifier to drive the loudspeakers in each zone. The 218s and 258 power amplifier are located in the central rack along with any automation equipment.

- Connect the analogue output of each 218 to a pair of inputs on the 258 using phono leads.
- Connect the speakers in each zone to the 258 using phoenix connectors.
- Connect the 218 to the LAN using an RJ45 cable.

The system can be controlled using a remote control for the automation system; it will have access to each 218's Automation Interface. The controls that are presented to the user will depend on the UI chosen by the installer.

## 14 Meridian 218 Zone Controller *User Guide*

### Installing 218 Zone Controllers in a rack tray

A 218 Rack Tray is available separately, to allow two 218s to be mounted in a standard 19" rack. The Rack Tray is supplied with the necessary screws.

The MAC address of each 218 is provided on the base of the unit, and we recommend that this is recorded on the tray as it is installed so that it can be identified in future. An adhesive label is supplied with each 218 for this purpose.

Note that if only one 218 is being installed in a tray then the open side of the fascia can be blanked by one of the knock-outs included in the tray. Remove the knock-out from the tray and bend the two longer tabs to 90 degrees. Affix the two self-adhesive dots and slide the shorter tabs down between the fascia and the tray, resting the longer tabs on the top surface of the tray. Press the knock-out firmly against the back of the fascia to secure.

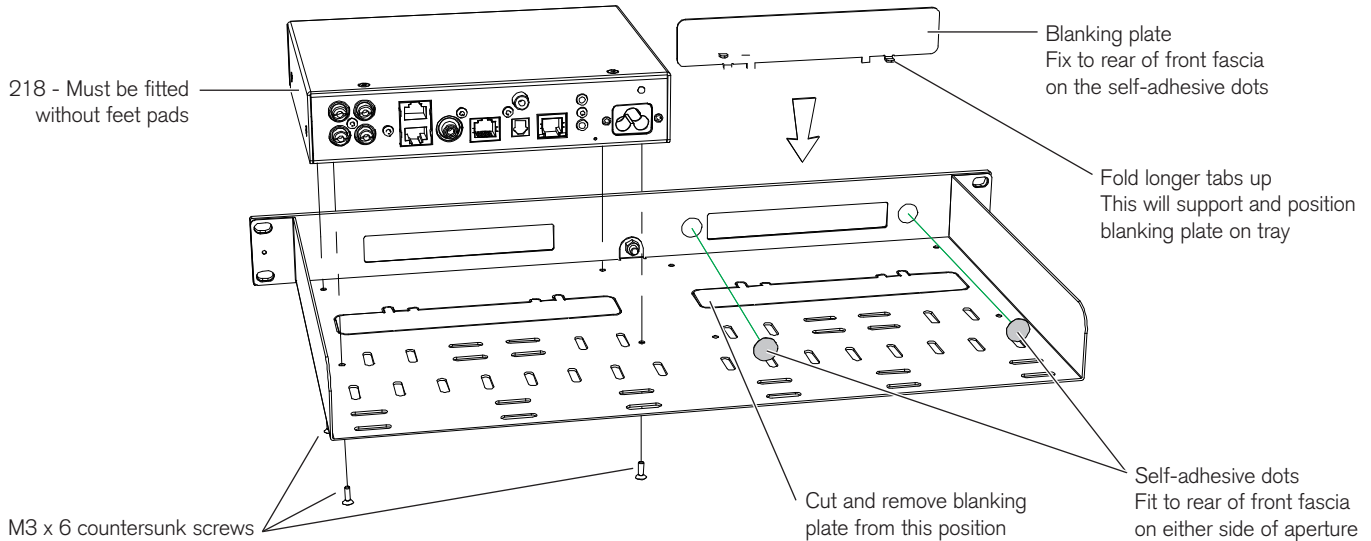

# Configuring the 218 Zone Controller

The 218 contains a built-in web interface, allowing it to be configured via the Ethernet connection using a standard web browser.

## Running the configuration interface

### To run the configuration interface:

- Connect the 218 to a network.
- Identify the IP address assigned to the 218 (see below).
- Type this address into the address bar of a standard web browser running on a computer or tablet on the same network.

You should then see the Meridian 218 Status page. This allows you to see or change the 218 settings, and also gives access to an online version of this user guide.

Full details of each of the sets of settings are given in the following sections.

### To store the settings

After changing any settings click the **Store Settings** button below the settings panels.

## Discovering the IP address of the 218

To discover the IP address of the 218 you can use any of the following methods:

- On a Sooloos network it can be found using the Sooloos Configuration Tool.
- On a Touch:PC it can be found using the Device Manager.
- Log in to the network router and view the list of attached devices.
- Use a network IP scanner to 'ping' a list of addresses on the network.

## Identification



**Sooloos Zone Name:** This identifies the product in the appropriate control interface such as Touch:PC, Control:15, and Control:PC. It is initially set to a unique string, but would normally be set to a meaningful label such as Kitchen or Study.

## 16 Meridian 218 Zone Controller *User Guide*

### Comms configuration

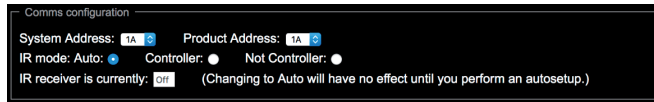

**System Address:** If an installation contains multiple zones that are connected together with Meridian Comms, each one needs a different System Address if they are to have independent source selection and volume controls. If the installation uses LAN connections then this can be left at its default, **1A**.

**Product Address:** If there are two or more Meridian sources in the same category on the same Comms-connected system then each unit must have a different Product Address. The setting does not apply to IP connected systems and should be left at its default, **1A**.

**IR mode:** The IR mode is only relevant if a G12 has been connected to the 218. In this setup the installer should set the mode to **Controller** to ensure that the unit functions as the system controller.

### Audio output

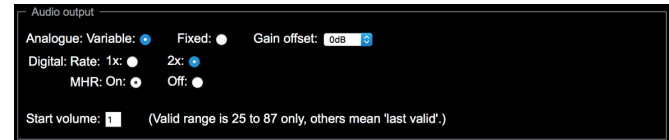

**Analogue:** Choose **Variable** if the 218 is to control the volume of the analogue outputs, or **Fixed** if the analogue outputs are connected to a preamplifier with its own volume control.

**Gain offset:** Can reduce the level of the analogue output by up to 10dB to match the input of the attached device.

**Digital:** For older DSP loudspeakers set **Rate** to **1x** and MHR to **Off**. For newer 96/24 and SE loudspeakers set **Rate** to **2x** and MHR to **On**.

**Start volume:** Specifies the initial volume for the analogue outputs (if variable) and, if the 218 is a Controller, sent on Meridian Comms for DSP loudspeakers. The start volume is set when the 218 is first powered up, and a few seconds after going into standby.

By default the 218 starts at volume 65 and retains the last volume setting when it enters and leaves standby.

## Source configuration

Source configuration										
	Legend	Audio Input	Sensitivity	Trigger	FIFO	Validity	Lipsync	Comms Type	Address	
CD:	CD	Digital	2.0V	On	<input checked="" type="checkbox"/>	<input checked="" type="checkbox"/>	0	1C	1A	
Radio:	Radio	Analogue	2.0V	On	<input checked="" type="checkbox"/>	<input type="checkbox"/>	0	2C	1A	
SLS:	SLS	Sooloos		On	<input checked="" type="checkbox"/>	<input checked="" type="checkbox"/>	0	4C	1A	
TV:	TV	Digital		On	<input checked="" type="checkbox"/>	<input type="checkbox"/>	0	NC	1A	
Tape:	Tape	Analogue	2.0V	On	<input checked="" type="checkbox"/>	<input type="checkbox"/>	0	NC	1A	
Sat:	Sat	Optical		On	<input checked="" type="checkbox"/>	<input type="checkbox"/>	0	NC	1A	
Disc:	Disc	SpeakerLink		On	<input checked="" type="checkbox"/>	<input type="checkbox"/>	0	NC	1A	
Cable:	Cable	Optical		On	<input checked="" type="checkbox"/>	<input type="checkbox"/>	0	NC	1A	
DVD:	DVD	SpeakerLink		On	<input checked="" type="checkbox"/>	<input type="checkbox"/>	0	NC	1A	
PVR:	PVR	Optical		On	<input checked="" type="checkbox"/>	<input type="checkbox"/>	0	NC	1A	
USB:	USB	Digital		On	<input checked="" type="checkbox"/>	<input type="checkbox"/>	0	NC	1A	
Game:	Game	Optical		On	<input checked="" type="checkbox"/>	<input type="checkbox"/>	0	NC	1A	
Startup source:		SLS								

**Legend:** A string of up to 5 characters which will be displayed on the Automation interface and on newer SpeakerLink-enabled DSP loudspeakers.

**Audio input:** Each of the 12 logical sources can be assigned to any of the audio inputs: **Analogue**, **Digital**, **Optical**, **SpeakerLink**, or **Sooloos**. Alternatively any source can be set to **Last Valid**, which changes the other settings but leaves the input unchanged, or **Off**, which makes the source unavailable.

**Sensitivity:** For analogue inputs you can select one of five sensitivities: the maximum RMS voltage that can be input before clipping occurs in the ADC.

**Trigger:** Can be set to **On**, **Off**, or **LV** (Last Valid) to control the trigger output. Note that the trigger is always off in standby.

**FIFO:** The FIFO box would normally be checked, but can be unchecked for digital sources with a poor quality clock that the 218 is unable to reclock.

**Validity:** Some sources, such as the Meridian CD players, use the Validity flag in the S/PDIF audio stream to indicate that the audio should not be played. Setting this may reduce unwanted noises in some situations.

**Lipsync:** Allows you to delay the audio by up to 85msec so that it aligns correctly with a video signal that has been delayed by a scaler.

**Comms Type:** For Comms-connected systems, ensures that the appropriate set of commands is sent to the product. The following categories are available:

**1C** = CD player, **2C** = Radio, **3C** = DVD player, **4C** = Sooloos  
All others should be set to **NC** (No Comms).

**Address:** If there are two or more products of each type then the address should be **1A** for the first, **2A** for the second, etc.

**Startup source:** Specifies the source that the 218 will start with if the user has a Source key on their chosen user interface.

## 18 Meridian 218 Zone Controller *User Guide*

### Audio menus



Values set here will be used by the 218 after power up. They can be adjusted at run time and stored (via the Automation Interface).

**Treble:** Tilts the frequency of the response over the entire frequency range to make the sound brighter or dimmer. It can be adjusted between  $\pm 10$ db in 0.5dB steps.

**Bass:** Adjusts the bass response in the room by  $\pm 5$ dB in 0.5dB steps.

**Axis:** Allows you to compensate for the height of the listener relative to the tweeter. It can be adjusted between -2 and +3, where 0 corresponds to the axis of the tweeter.

**Phase:** Changes the absolute phase of the signal, to compensate for signals which are out of phase, giving an unnatural-sounding bass.

**Balance:** Compensates for an off-centre listening position where 0 is central, 8 is in line with the corresponding main

speaker, and 10 is fully to one side.

Note: **Treble**, **Bass**, and **Balance** are always sent to DSP speakers, but only affect the analogue outputs when the 218 is set up with variable outputs. The **Axis** control only applies to digital outputs.



## SpeakerLink configuration

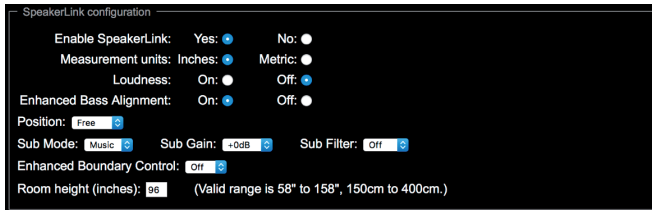

This section sets the parameters that are transmitted to SpeakerLink connected DSP loudspeakers.

Note: The effect of these options depends on the capabilities of the DSP loudspeakers in the system; see the individual loudspeaker user guide for more information.

**Enable SpeakerLink:** Should be set to **No** if older DSP speakers are used.

**Measurement units:** Changes the units used for specifying **Room height**.

**Loudness:** Set to **On** to alter the frequency response to make music sound more natural when played at a low volume setting.

**Enhanced Bass Alignment:** improves the bass alignment in DSP loudspeakers that support it. Note that the extra processing adds a time delay, so it may need to be disabled for video sources.

**Position:** Adjusts the sound to compensate for the placement of the main loudspeakers: **Corner**, **Shelf**, **Wall**, or **Free**.

**Sub Mode:** Changes the distribution of bass between the main speakers and the subwoofer to suit **Music** or **Movie** material.

**Sub Gain:** Adjusts the subwoofer gain between +15dB and -15dB.

**Sub Filter:** Adjusts the subwoofer crossover frequency. The options are **Off** (subwoofer off), **Sub1** (80Hz crossover), or **Sub2** (120Hz crossover).

**Enhanced Boundary Control:** Compensates for reflective room surfaces. Choose between **Off** (unreflective), **Min**, **Med**, or **Max** (highly reflective).

**Room height:** Used for Enhanced Boundary Control calculations in loudspeakers with downward-firing drive units, such as the M6 or DSW, to compensate for reflections with the room ceiling. Can be varied between 150cm (58in) and 400cm (158in) in steps of 5cm (2in). If the room height is outside this range set the nearest available value.

### Ethernet configuration

Ethernet configuration

Active ethernet address: 192.168.3.100  
Active ethernet mask: 255.255.255.0  
Active ethernet gateway: 192.168.3.1  
Active ethernet DNS: 208.67.222.222

DHCP:  Static IP:

Static ethernet address: 192 . 168 . 1 . 80  
Static ethernet mask: 255 . 255 . 255 . 0  
Static ethernet gateway: 192 . 168 . 1 . 1  
Static ethernet DNS: 192 . 168 . 1 . 1

Allows you to change the Ethernet configuration. Please note that incorrect settings may make the 218 unreachable via the web page.

# Controlling the 218 Zone Controller

The Meridian 218 can be controlled using the following options:

- Via Meridian Comms from another product such as a DSP loudspeaker.
- Via the Ethernet connection using the Sooloos system.
- Via the Ethernet connection using the 218 Automation Interface.
- Via Infra Red, using the optional G12 remote IR sensor and either the MSR, MSR+, or AC200 remote controls.

For details of the Automation Interface and the IR control codes see the Meridian website:

[www.meridian-audio.com](http://www.meridian-audio.com)

A sample application called IP Control that uses the Automation Interface is available for iPad devices on the Apple Store; search for Meridian.

## **Ethernet connection**

A LAN connection is required to configure the 218 Zone Controller. Also, various aspects of the update and support systems require that the LAN allows Link Local addressing and multicast transmission as well as UDP and TCP traffic (for the music stream and its control). Simple unmanaged switches will always pass this traffic but Wireless Access Points should be

selected carefully and managed switches must be configured correctly to pass this traffic.



# Index

## A

---

Address option 17  
Analogue 16  
analogue inputs 6  
analogue outputs 6  
analogue system 12  
applications  
    analogue system 12  
    audio-visual system 8  
    distributed zone 10  
    minimal system 7  
audio-visual system 8  
Audio input option 17  
Audio menu panel 18  
Audio output panel 16  
Automation Interface 21  
auxiliary output 5  
Axis option 18

## B

---

back panel connections 5  
Balance option 18  
Bass option 18

## C

---

Comms, connecting 6  
Comms configuration panel 16  
Comms Type option 17  
communications connections 6  
configuration 15  
controlling the 218 21

## D

---

digital inputs 6  
Digital option 16  
digital output 6  
distributed zone 10

## E

---

Enable SpeakerLink option 19  
Enhanced Bass Alignment option 19  
Enhanced Boundary Control option 19  
Ethernet configuration panel 20  
Ethernet connection 21

## F

---

FIFO option 17  
front-panel indicators 6

## G

---

Gain offset option 16

## I

---

Identification panel 15  
indicators 6

## 24 Meridian 218 Zone Controller *User Guide*

inputs 6  
    analogue 6  
    digital 6  
    optical 6  
    SpeakerLink 6  
installation  
    rack tray 14  
IP Control application 21  
IR input 6  
IR mode option 16

### L

---

Legend option 17  
Lipsync option 17  
Loudness option 19

### M

---

MAC address 14  
Measurement units option 19  
Meridian 258 Multi Channel Power  
    Amplifier 13

minimal system 7  
MQA status 6

### O

---

optical input 6  
outputs 6  
    analogue 6  
    digital 6  
    SpeakerLink 6

### P

---

panels  
    Audio menus 18  
    Audio output 16  
    Comms configuration 16  
    Ethernet configuration 20  
    Identification 15  
    Source configuration 17  
    SpeakerLink configuration 19  
Phase option 18  
Position option 19  
Product Address option 16

### R

---

rack tray, installing in 14  
registration iv  
Room height option 19

### S

---

safety warnings iii  
Sensitivity option 17  
Sooloos Zone Name option 15  
Source configuration panel 17  
SpeakerLink  
    inputs 6  
    outputs 6  
SpeakerLink configuration panel 19  
specifications 3  
Startup source option 17  
Start volume option 16  
Sub Filter option 19  
Sub Gain option 19  
Sub Mode option 19  
System Address option 16

## T

---

Treble option 18

Trigger option 17

trigger outputs 6

## V

---

Validity option 17

