

Ultra Digital to Analogue Converter User Guide



Important safety instructions

- Read the instructions.
- Keep these instructions.
- Follow all instructions.
- Do not use this apparatus near water.
- Clean only with a dry cloth.
- Install only in accordance with the manufacturer's instructions.
- Refer all servicing to approved service personnel.

WARNING: TO REDUCE THE RISK OF FIRE OR ELECTRIC SHOCK, DO NOT EXPOSE THIS APPARATUS TO RAIN OR MOISTURE.

This apparatus has been designed with Class 1 construction and must be connected to a mains socket outlet with a protective earthing connection (the third grounding pin).

This apparatus uses a single-pole power switch. As a result it is not isolated from AC mains power when switched off at the rear panel. The apparatus may be isolated from mains power either by unplugging the power connector from the rear of the unit, or by unplugging the connector at the opposing end of the power cord or cable from its supply outlet. As a result, either or both of these connectors should remain accessible.

Safety warnings

- Do not expose the unit to dripping or splashing.
- Do not place any object filled with liquid, such as a vase, on the unit.
- Do not place naked flame sources, such as lighted candles, on the unit.

To avoid overheating

- Leave at least 10cm around the equipment to ensure sufficient ventilation.

Do not position the unit:

- In direct sunlight.
- Near heat sources, such as a radiator.
- Directly on top of heat producing equipment, such as a power amplifier.

To avoid interference

Do not position the unit:

- Near strong electrical or magnetic radiation, such as near a power amplifier.

Radio interference

FCC Warning: This equipment generates and can radiate radio frequency energy and if not installed and used correctly in accordance with our instructions may cause interference to radio communications or radio and television reception. It has been type-tested and complies with the limits set out in Subpart J, Part 15 of FCC rules for a Class B computing device. These limits are intended to provide reasonable protection against such interference in home installations.

EEC: This product has been designed and type-tested to comply with the limits set out in EN55013 and EN55020.



Contents

Introduction	1	Configuring the Ultra Digital to Analogue Converter	23
The Ultra Digital to Analogue Converter	2	Choosing a standard setting	24
Specifications	3	Setup parameters	25
Using the Ultra Digital to Analogue Converter	5	Setting the startup volume and output mode	26
Front panel keys	6	Adding a gain offset	27
MSR+ keys	7	Installing the Meridian Configuration Application	28
Switching on and off	8	Index	29
Selecting a source	9		
Adjusting the system volume	10		
Changing the treble, bass, or balance	11		
Changing the DSP filter	12		
Changing the phase or lipsync	13		
Changing the front-panel display	14		
Installing the Ultra Digital to Analogue Converter	15		
Unpacking	16		
Applications	18		

Copyright and acknowledgements

Sales and service in the UK

Meridian Audio Ltd
Latham Road
Huntingdon
Cambridgeshire
PE29 6YE
England

Tel (01480) 445678
Fax (01480) 445686

Sales and service in the USA

MAI
351 Thornton Road
Suite 108
Lithia Springs, GA
30122
United States

Tel 404-344-7111
Fax 404-346-7111

Designed and manufactured in the UK

Meridian Audio Ltd
Latham Road
Huntingdon
Cambridgeshire
PE29 6YE
England

Visit us on the Web

www.meridian-audio.com

Copyright © 2016 Meridian Audio Ltd.

Part no: P88447

MHR: this product incorporates copyright protection technology covered by certain patent applications and intellectual property of Meridian Audio Ltd. This technology is provided for the express purpose of securely containing copyright audio within the Meridian System only. Reverse engineering or circumvention of this protection is strictly prohibited.

Hierarchical Converter Technology by MOA is used under licence from MOA Ltd.

Boothroyd|Stuart Meridian, Meridian, and Sooloos are registered trademarks of Meridian Audio Ltd.

This guide was produced by:
Human-Computer Interface Ltd,
www.interface.co.uk

Product registration

Register your Meridian Ultra Digital to Analogue Converter at:

www.meridian-audio.com/support

and receive Exclusive Meridian News and discover more about the Meridian Collection.

Introduction

Welcome to the Meridian Ultra Digital to Analogue Converter.

This User Guide provides full information about using the product in conjunction with your other equipment, to achieve the superb results you can expect from it.



The Ultra Digital to Analogue Converter

The Meridian Ultra Digital to Analogue Converter has been designed to reconstruct the highest possible quality analogue audio signal from a wide range of digital inputs. It is based on Meridian's experience and research into digital and analogue audio over many years.

Outputs

The Ultra Digital to Analogue Converter provides a choice between balanced analogue outputs, using XLR connectors, or unbalanced analogue outputs, using phono connectors.

The output circuitry incorporates Hierarchical Converter Technology, by MQA, which employs multiple converters to increase temporal resolution while also reducing noise and quantization errors. The result is a level of performance that is unachievable with normal DACs.

Inputs

On the input side, the Ultra Digital to Analogue Converter provides a wide range of digital inputs to cater for almost any digital source. It can accept signals up to 384kHz (USB input) or 192kHz (other inputs).

Two balanced XLR digital inputs are provided, for sources with balanced digital outputs. A balanced SpeakerLink input is also provided, for connecting to other Meridian sources with SpeakerLink outputs.

Two unbalanced digital inputs are provided using BNC connectors. In addition, two digital coaxial inputs and two Toslink optical digital inputs are provided, for connecting to other digital sources.

The Ultra Digital to Analogue Converter provides a network socket to connect it to a Meridian Sooloos System, Meridian's music management platform.

A USB B-type connector is provided to allow the Ultra Digital to Analogue Converter to be connected to a computer system and used as an external sound card.

Audio processing

The Ultra Digital to Analogue Converter processes signals with Meridian's exclusive apodising filter, ensuring maximum audio quality. All lower bit-rate signals are upsampled to 352/384kHz to allow a wider choice of high-quality filters. Three upsampling filtering options are provided, allowing you to choose the best option for different types of audio material.

The Ultra Digital to Analogue Converter will also automatically decode MQA (Master Quality Authenticated) audio streams. When an MQA stream is detected the front panel display will indicate MQA.

The Ultra Digital to Analogue Converter can be configured to provide tone adjustments, as well as balance and volume controls, for use with power amplifiers or active analogue loudspeakers. Alternatively it can be configured for fixed output, for connection to an external analogue preamplifier.

System integration

An RS232 interface provides full remote control capability as well as the ability to configure the unit with Meridian's innovative Windows-based graphic configuration application.

Three programmable trigger outputs are provided for direct control of external devices.

The Ultra Digital to Analogue Converter is supplied with the MSR+ learning/programmable remote control, which operates all Meridian products and includes an extensive database of third-party products and the capability to learn commands from existing remotes.

Specifications

Audio outputs

- 2-channel balanced audio output.
- 2-channel unbalanced audio output.
- Outputs driven by four 192kHz digital to analogue converters.

The output stage incorporates Hierarchical Converter technology, by MQA.

Audio inputs

- Two 2-channel balanced XLR inputs (110 Ω). 44.1kHz to 192kHz sampling and up to 24-bit precision.
- Two 2-channel BNC coax inputs (75 Ω). 44.1kHz to 192kHz sampling and up to 24-bit precision.
- Two 2-channel digital coax inputs (75 Ω). 44.1kHz to 192kHz sampling and up to 24-bit precision.
- One 2-channel Meridian SpeakerLink input. 44.1kHz to 192kHz sampling and up to 24-bit precision.
- Two 2-channel digital optical inputs. 44.1kHz to 96kHz sampling and up to 24-bit precision.
- One network input (Ethernet) for connection to a Meridian Sooloos System.
- One USB 2.0 input, for connection to a computer. Up to 384kHz sampling and up to 24-bit precision.
- All inputs provide renameable legends.

Control signals

- Three 12VDC/100mA trigger outputs configurable by source.
- Two Meridian Comms 5-pin 240° DIN sockets.
- RS232 interface for maintenance.

Signal processing

The Ultra Digital to Analogue Converter uses Meridian's proprietary DSP software to provide the following powerful features:

- Apodising filter.
- Upsampling.
- FIFO and error correction.
- Resolution enhancement.
- MQA decoding and rendering.

Controls

Front-panel facia controls for:

- Source, DSP, Display, Mute, and Off.

A hinged control panel provides additional controls for:

- Volume +/-, Setup, and Menu keys.

Display

- 20-character dot-matrix display with adjustable brightness and contrast.
- Indicators for Emphasis and Phase.

Using the Ultra Digital to Analogue Converter

This chapter provides a summary of the functions of the Ultra Digital to Analogue Converter to identify the controls you use to operate the unit.

It also provides step-by-step instructions for operating the Ultra Digital to Analogue Converter, using either the front panel or the MSR+.



Front panel keys

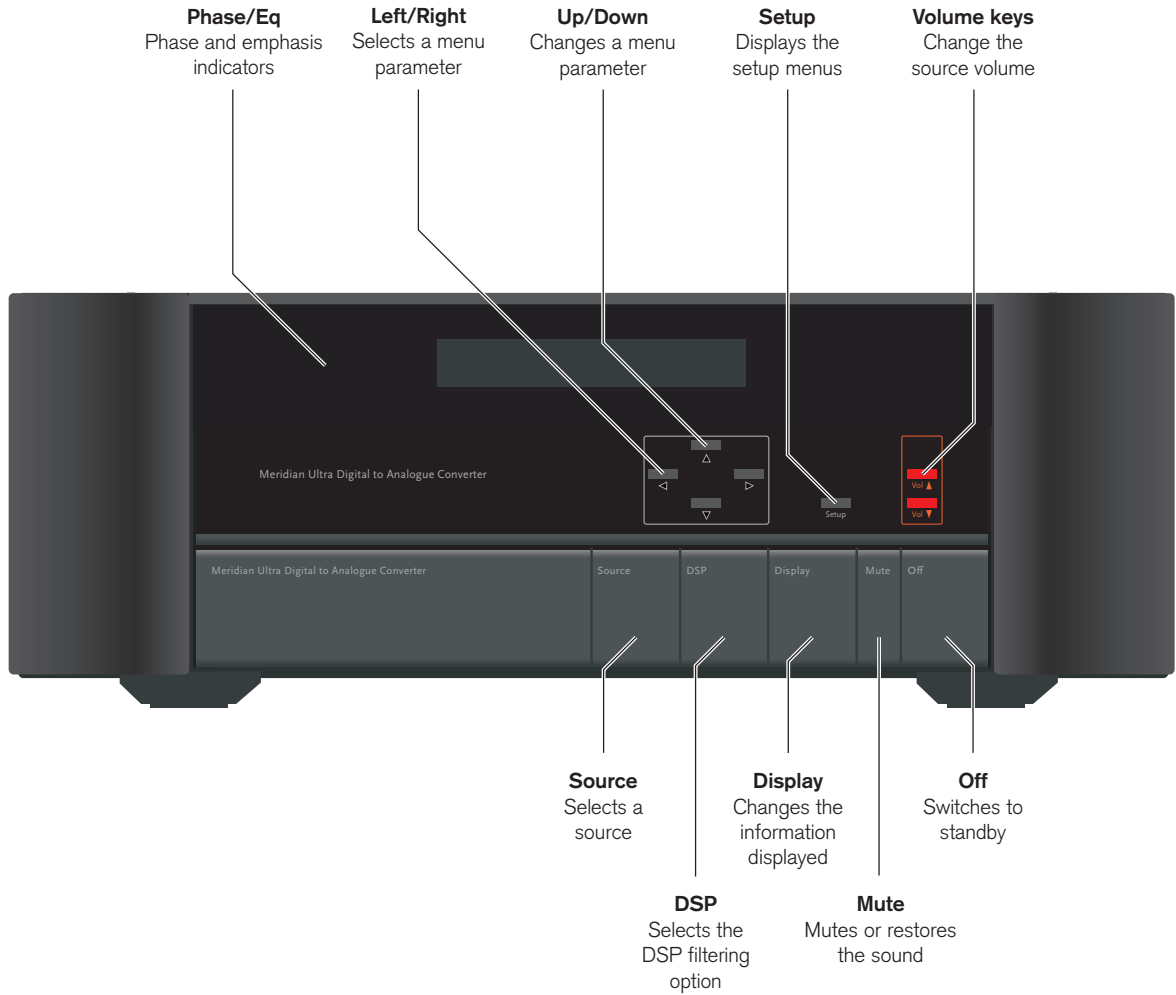

MSR+ keys

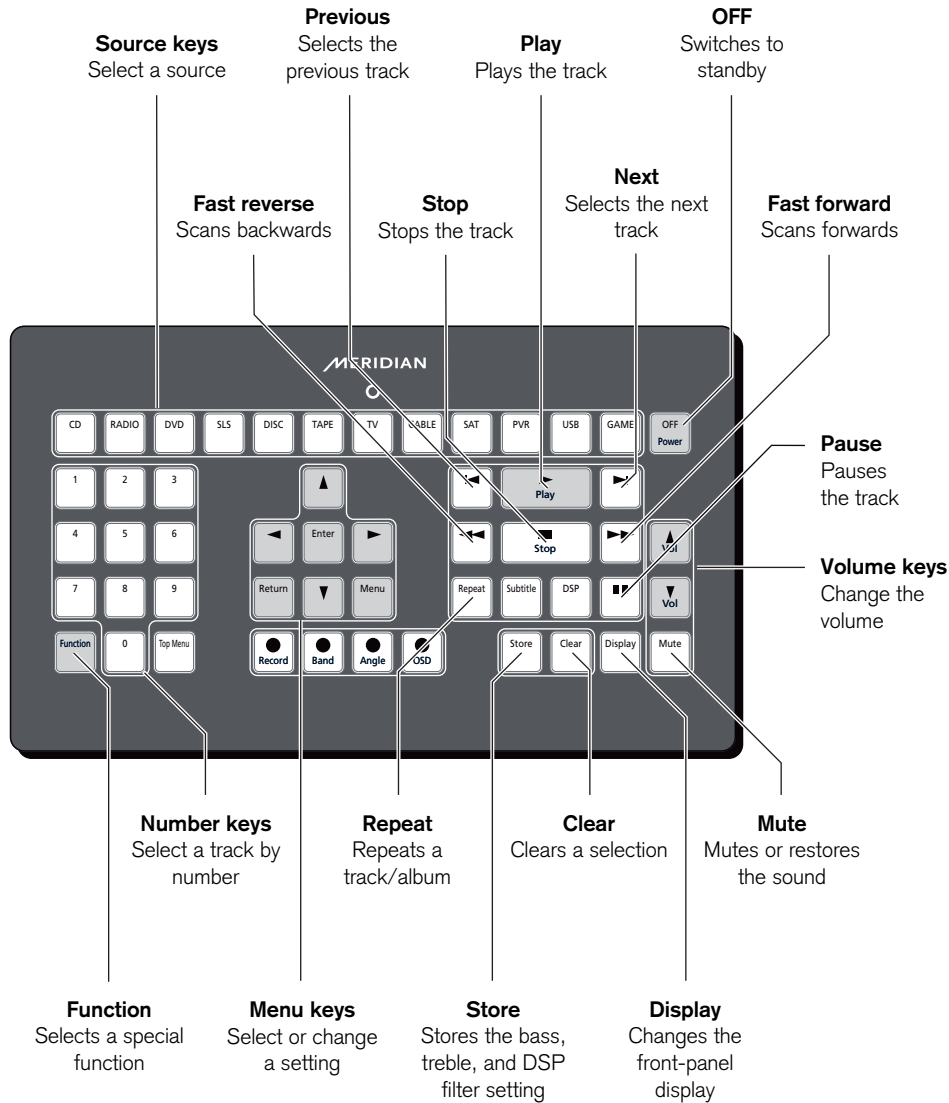

Switching on and off

When not playing, the Ultra Digital to Analogue Converter should be left in the standby state. This uses a minimal amount of electricity, but ensures that the components of the Ultra Digital to Analogue Converter operate at maximum efficiency from the moment you start.

If you are not going to use the Ultra Digital to Analogue Converter for several days you should switch the unit off completely at the rear panel, and disconnect it from the AC power supply.

To switch on from standby

- Press **Source** (front panel), or select a source on the remote.

If the Ultra Digital to Analogue Converter is part of a Meridian system it will automatically switch on any other units in the system.

To switch to standby

- Press **Off** (front panel or remote).

Selecting a source

The Ultra Digital to Analogue Converter responds to the following 12 source keys on the remote:

CD, Radio, DVD, SLS, Disc, Tape, TV, Cable, Sat, PVR, USB, and Game.

The input associated with each of the sources depends on how the Ultra Digital to Analogue Converter has been set up; for more information refer to the *Meridian Configuration Program Guide*.

Your installer may have customised the labels displayed for each source to suit your other equipment.

To select a source

- Press **Source** (front panel) until the display shows the source you want, or press the appropriate source key on the remote; eg **USB**.

If the Ultra Digital to Analogue Converter is configured with variable output the display shows the source and volume setting. For example, if you select the USB source:

The display shows:



If the Ultra Digital to Analogue Converter is configured with fixed output the display shows just the source:

For example:



The Ultra Digital to Analogue Converter mutes the sound while you change source.

To play music from a Sooloos system

Either:

- Press **Source** (front panel) until the display shows SLS, or press the **SLS** key on the remote.

Or:

- Select the Ultra Digital to Analogue Converter zone from the Sooloos controller.

You can then listen to music streamed from the Sooloos server.

The Ultra Digital to Analogue Converter will be operated by the mute control on the Sooloos controller, and also the volume controls if the Ultra Digital to Analogue Converter is set up with variable output.

To control the Sooloos system

When the SLS source is selected you can control the Sooloos system from the MSR.

- Press **■**, **||**, or **▶** (remote) to control playback.
- Press **◀** or **▶** (remote) to step between tracks in the Sooloos play queue.

For more information please refer to the *Meridian Sooloos Network Card Guide*.

Adjusting the system volume

If the Ultra Digital to Analogue Converter has been set up with variable output the volume control adjusts the volume in precise steps of 1dB, where 9dB is equivalent to doubling the loudness. The current volume setting is displayed in dB on the front-panel display, and can be varied in the range 1 to 99dB.

You can choose what startup volume is set when you switch the Ultra Digital to Analogue Converter on; see *To set the startup volume*, page 26.

To change the volume

- Press **Volume ▲** or **Volume ▼** (under the front panel), or the red **▲** or **▼** keys on the remote.

As you adjust the volume setting the display shows the current volume level.

For example:



To mute the sound

- Press **Mute** (front panel, remote, or under the front panel).

The display shows:



To restore the sound

- Press **Mute** again.

Alternatively, the sound will be restored if you adjust the volume, or select a source.

Mute is available even if the Ultra Digital to Analogue Converter is set up with fixed output.

Changing the treble, bass, or balance

If the Ultra Digital to Analogue Converter has been set up with variable output, treble, bass, and balance controls allow you to adjust the broad balance of the sound to correct for the acoustics of your listening room, or for a misbalanced recording.

The controls are more subtle than conventional tone controls, and take advantage of digital signal processing techniques to provide a more natural adjustment of the frequency response.

You can store your treble and bass settings permanently; see *To store the audio settings*, page 12

The balance control uses digital signal processing to compensate for an off-centre listening position by delaying and diminishing the sound in one speaker, thus effectively shifting the speaker's image back.

To change the treble

- Press ◀ or ▶ (remote or under the front panel) until the display shows the current treble.

For example:

- Press ▲ or ▼ (remote or under the front panel) to change the treble.

The treble control tilts the frequency of the response over the entire frequency range to make the sound brighter or dimmer. It can be adjusted between ± 10 db in 0.5dB steps. Normally settings between +1.0 and -2.0 will give the most natural results.

To change the bass

- Press ◀ or ▶ (remote or under the front panel) until the display shows the current bass setting.

For example:

- Press ▲ or ▼ (remote or under the front panel) to change the bass.

The bass control allows you to adjust the bass response in the room by ± 5 dB in 0.5dB steps. Normally settings between +3.0 and -2.0 will give the most natural results.

To change the balance

- Press ◀ or ▶ (remote or under the front panel) until the display shows the current balance.

For example:

- Press ▲ or ▼ (remote or under the front panel) to move the listening position.

The display shows the direction and position of the listening position.

For example:

The arrow indicates the direction, and the number indicates the position where 0 is central, 8 is in line with the corresponding main speaker, and 10 is fully to one side.

The current balance setting is stored permanently.

Changing the DSP filter

The Ultra Digital to Analogue Converter allows you to select the upsampling filter used for reproducing sources with a sample rate of 44kHz or 48kHz, such as CD or DAT.

Three options are available:

Filter	Description
Short	A filter with fewer stages, giving a shallower response. It provides the best time response, emphasising the spatial cues in well recorded music.
Medium	A good compromise between removing artefacts and preserving spatial information.
Long	A filter with more stages, giving a steeper response. It removes artefacts created by pre-echo or noise in the recording and mastering process, giving a more musical sound where artefacts are present.

To change the upsampling filter

- Press ◀ or ▶ (remote or under the front panel), until the display shows the current upsampling filter.

For example:

USB Filter Long

- Press ▲ or ▼ (remote or under the front panel), to change the filter.

For example:

USB Filter Medium

To store the audio settings

You can store your preferred settings in the Ultra Digital to Analogue Converter.

- Press **Function Store** (remote).

The display shows:

Stored

The following table shows which settings are stored depending on how the Ultra Digital to Analogue Converter has been set up:

Mode	Settings stored
Variable Output	Treble, Bass, and Filter
Fixed Output	Filter

Changing the phase or lipsync

The Phase setting allows you to change the absolute phase of the signal, to compensate for signals which are out of phase, giving an unnatural-sounding bass.

The LipSync setting is a feature originated by Meridian that allows you to adjust the delay between the sound and the video image by up to 85ms.

Most movies are mixed for a viewing distance of 9m (30'), and when viewed from 3.6m (12') or less the sound arrives too early, giving a disconcerting effect. Using the LipSync setting you can add an overall delay to the sound to accommodate your closer home viewing distance.

Many TV broadcasts delay the picture by half a frame, and can benefit from a LipSync setting of 12ms.

The LipSync setting is stored for each source.

To change the phase

Either:

- Press ◀ or ▶ (remote or under the front panel) until the display shows the current phase.

For example:

- Press ▲ or ▼ (remote or under the front panel) to change the phase.

Or:

- Press **Function II** on the remote.

The display will show the new phase setting.

For example:

To adjust the LipSync

- Press ▶ or ◀ until the display shows the current LipSync setting.

For example:

- Press ▲ or ▼ to change the delay in milliseconds.

You can adjust the delay between 0 and 85ms, where 30ms corresponds to sitting 9m (30') further away from the screen.

Changing the front-panel display

The Ultra Digital to Analogue Converter displays information and settings on the 20-character front-panel display.

You can adjust the contrast and brightness of the front-panel display for optimum viewing, and choose what information is displayed.

To change the contrast or brightness

- Press ◀ or ▶ (remote or under the front panel), until the display shows the current contrast or brightness.

For example:



- Press ▲ or ▼ (remote or under the front panel), to change the selected setting.

You can change the contrast or brightness between 0 and 15.

To change the displayed information

- Press **Display** (front panel or remote).

Each time you press **Display** the display will step between the following options:

Display option	Example
Source and volume (variable output)	SLS 65
Source (fixed output)	SLS
Audio format	SLS PCM 44k
Blank	

If the Ultra Digital to Analogue Converter has detected an authentic MQA music stream the audio format display will indicate this, and show the original sample rate as encoded in the studio.

For example:



If the **Diagnostic displays** option has been selected, additional diagnostic displays are included; see *Setup parameters*, page 25.

Installing the Ultra Digital to Analogue Converter

This chapter explains how to install the Ultra Digital to Analogue Converter. It describes what you should find when you unpack the product, and how you should connect it to the other equipment in the system.

You should not make any connections to the product or to any other component in the system while the AC power supply is connected and switched on.



Unpacking

The Ultra Digital to Analogue Converter is supplied with the following accessories:

- MSR+ remote control with batteries, manual, and spare key caps.
- Meridian Comms lead.
- Power cord.
- This manual.

If any of these items are missing please contact your retailer.

NOTE: You should retain the packaging in case you need to transport the unit.

Back panel

The following diagram gives details of the back panel connections:

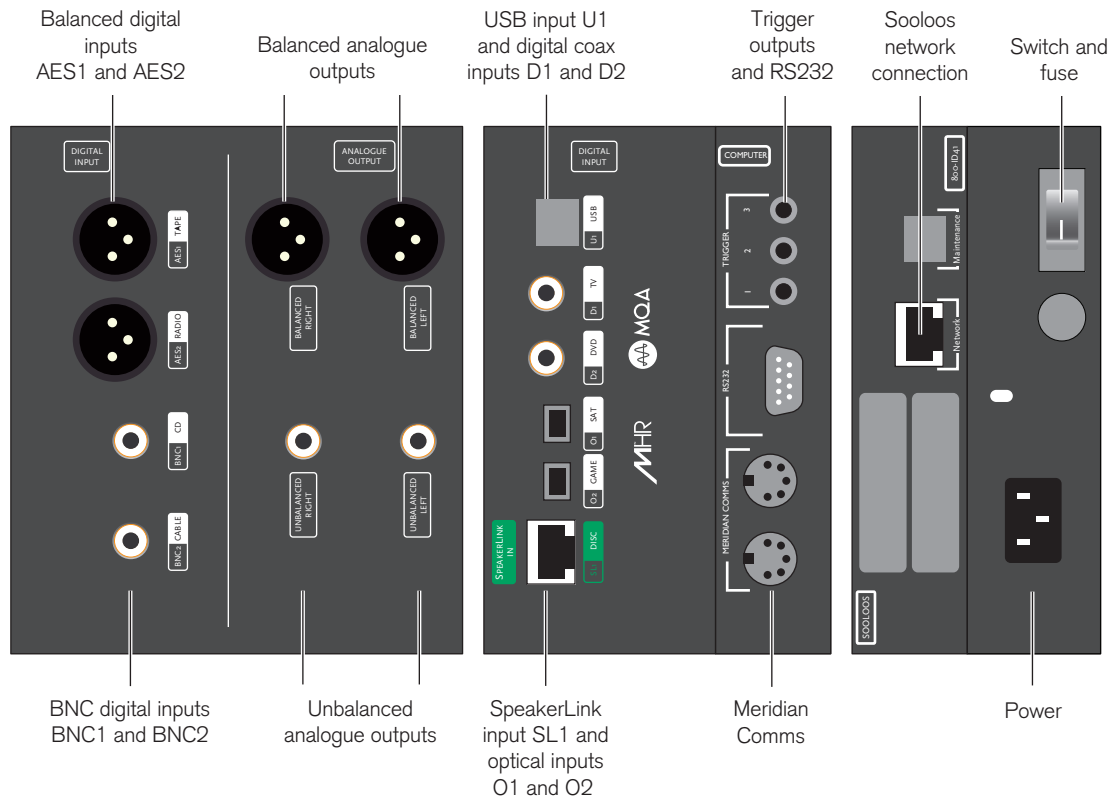

Audio outputs

Use this output	To connect to this
BALANCED OUT	The balanced analogue inputs of a preamplifier, or a power amplifier such as the 857, using XLR leads.
ANALOGUE OUT	The unbalanced analogue inputs of a preamplifier, or a power amplifier such as the 857, using analogue phono leads.

Audio inputs

Use this input	To connect to this
DIGITAL INPUT AES1 (Tape), AES2 (Radio)	The digital output of a source with balanced XLR outputs.
DIGITAL INPUT BNC1 (CD), BNC2 (Cable)	The digital output of a source with unbalanced BNC outputs.
DIGITAL INPUT D1 (TV, PVR), D2 (DVD)	The digital output of a source with unbalanced digital coax outputs.
OPTICAL INPUT O1 (Sat), O2 (Game)	The optical output of a source such as a satellite receiver.
USB INPUT (USB)	A personal computer USB socket.
NETWORK (SLS)	A Meridian Sooloos System.
SPEAKERLINK INPUT SL1 (Disc)	The SpeakerLink output of a Meridian source, using a Meridian SpeakerLink lead.

The default assignment of the source to each input is shown in brackets after the input name in the above table.

Communications connections

Use this connection	To connect to this
MERIDIAN COMMS	Other Meridian equipment, such as a CD player or tuner.
RS232 connection	A computer, for configuring the Ultra Digital to Analogue Converter, or a serial control system.
TRIGGER OUTPUT 1, 2, 3	Equipment to be triggered by a 12V 100mA signal.

Applications

To connect to a balanced digital source (eg DVD player)

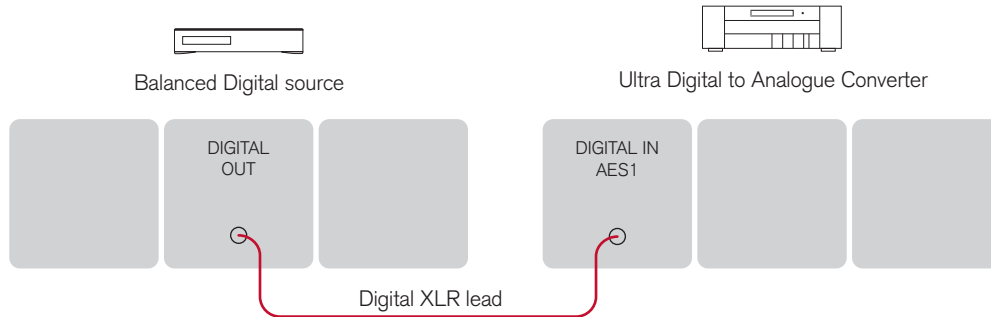

You can connect up to two balanced digital inputs to the Ultra Digital to Analogue Converter. If you have a choice of outputs these are the recommended option as they provide improved common-mode rejection.

- Connect the digital source to an appropriate digital input socket on the Ultra Digital to Analogue Converter, using a digital XLR lead.

To connect to an unbalanced digital source (eg TV tuner)

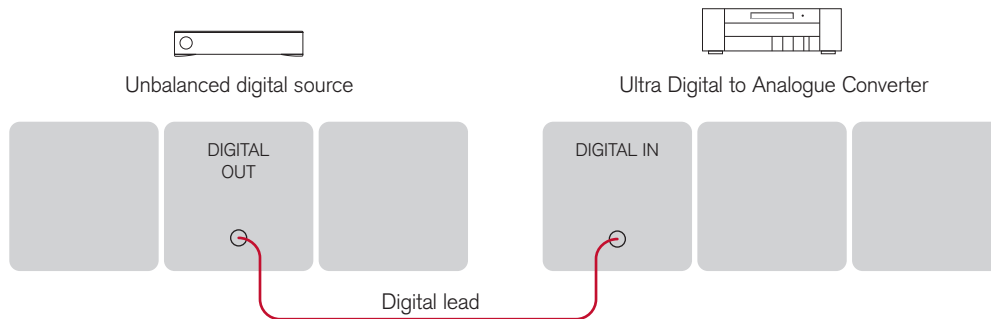

You can connect up to two digital BNC inputs, two digital coax inputs, and two digital optical inputs to the Ultra Digital to Analogue Converter.

- Connect the digital source to the appropriate digital input, using either a screened BNC lead, a screened coax phono lead, or a Toslink lead.

To connect to a computer via USB

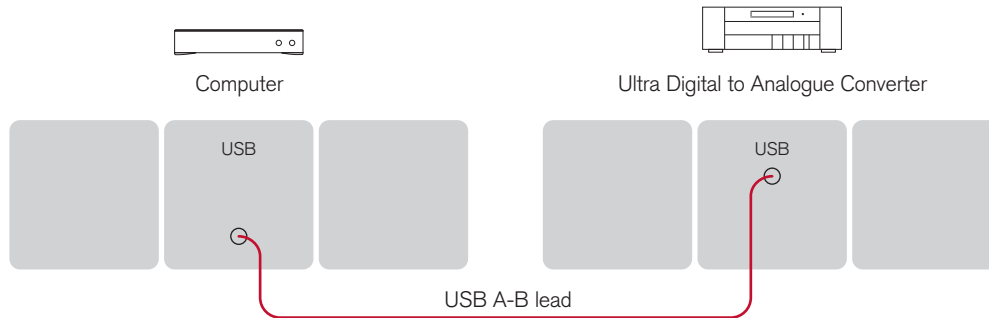

You can connect the Ultra Digital to Analogue Converter to a PC or Mac USB socket to allow you to use the Ultra Digital to Analogue Converter as a digital audio output device.

On a PC, Windows XP/SP2 or later is required. Note that you must install the drivers (available from your Meridian dealer or www.meridian-audio.com) before you connect the product to a Windows PC.

On a Mac, OS X 10.4 or later is recommended. Appropriate drivers will be installed automatically when you connect for the first time.

Linux computers that support USB Audio Class 2.0 drivers can also be used.

When the Ultra Digital to Analogue Converter is plugged in to the computer it will appear as a sound output device called **Meridian USB input** in the **Sound** control panel (PC) or **Sound** System Preferences panel (Mac).

The source will be labelled USB, unless it has been given a custom label.

The computer volume control will continue to work as expected, but for highest quality you should set it to maximum and use the volume control in the Ultra Digital to Analogue Converter or preamplifier instead.

To decode MQA content the computer volume control must be set to maximum, and any normalisation, sound effects, or mixing must be disabled to deliver the digital content unchanged.

To connect to a power amplifier

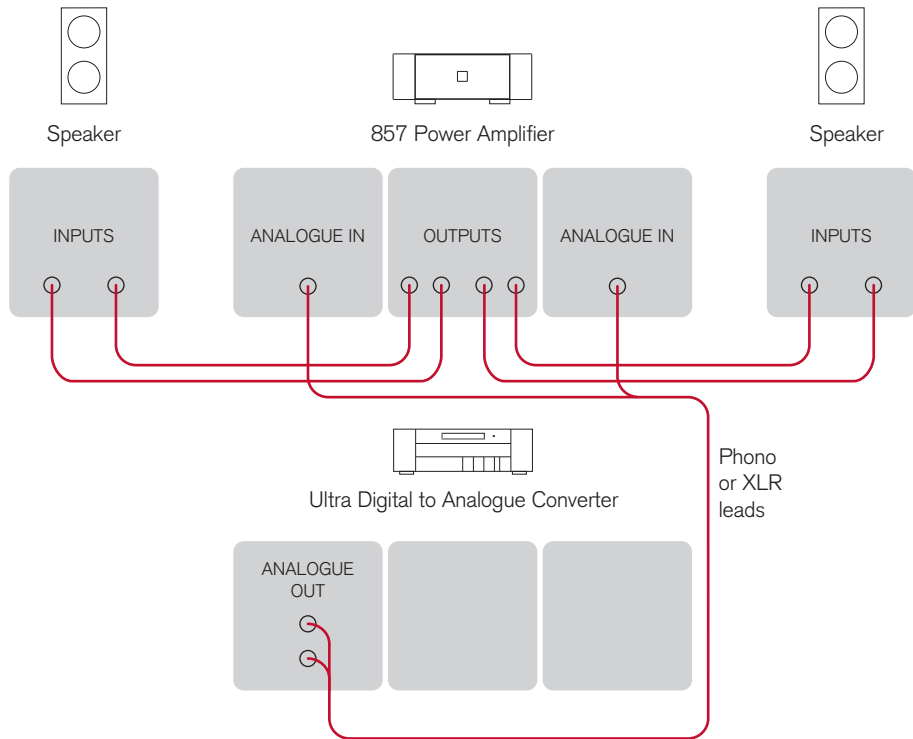

You can connect the Ultra Digital to Analogue Converter to a pair of analogue active loudspeakers, or to analogue passive loudspeakers via a power amplifier such as the Meridian 857 Power Amplifier.

- Connect the balanced or unbalanced ANALOGUE OUTPUT connections from the Ultra Digital to Analogue Converter to the inputs of the analogue active loudspeakers or power amplifier.
- Optionally connect the Trigger 1 output from the Ultra Digital to Analogue Converter to the 857 Trigger Input, to switch the power amplifier on and

off automatically from the Ultra Digital to Analogue Converter.

- Configure the Ultra Digital to Analogue Converter for variable output as described in *Configuring the Ultra Digital to Analogue Converter*, page 23, or by using the Meridian Configuration Application; see *Installing the Meridian Configuration Application*, page 28.

To connect to a preamplifier

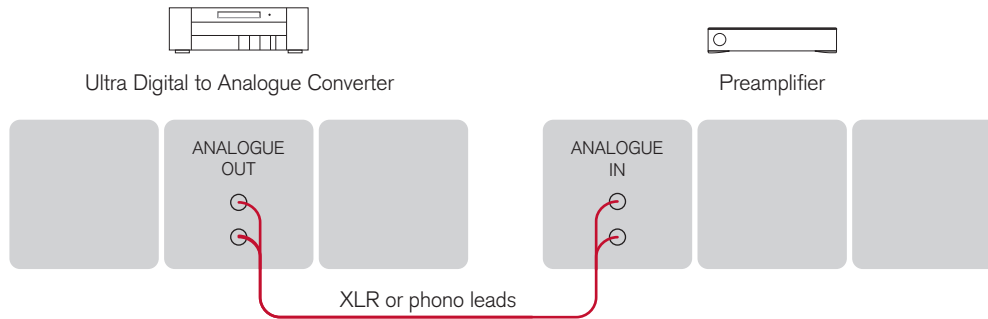

You can connect the Ultra Digital to Analogue Converter to an external preamplifier, which will then act as the volume control for the system.

- Connect the balanced or unbalanced outputs from the Ultra Digital to Analogue Converter to the analogue inputs on the preamplifier, using balanced or unbalanced leads as appropriate.
- Configure the Ultra Digital to Analogue Converter for fixed output as described in *Configuring the Ultra Digital to Analogue Converter*, page 23, or by using the Meridian Configuration Application; see *Installing the Meridian Configuration Application*, page 28.

If your preamplifier is particularly sensitive, or its input stage clips on loud material, you can adjust the gain offset of the outputs; see *To change the gain offset*, page 27

To connect to other Meridian G Series or 800 Series equipment

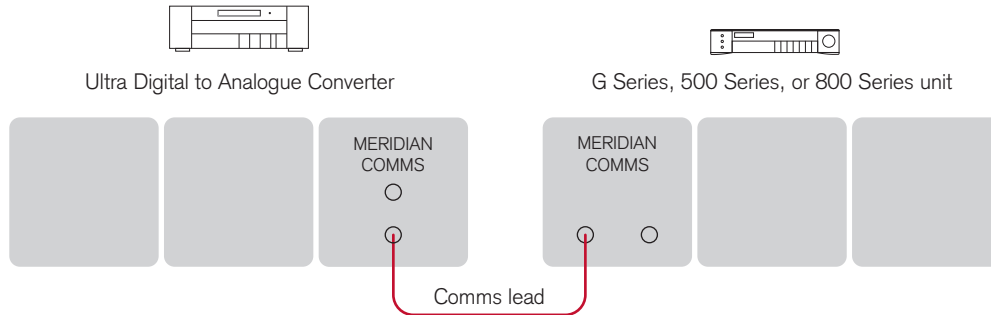

In a system of Meridian products, one of the products acts as the controller for the system, receiving infra-red commands from the MSR+ and then, if appropriate, relaying them to the other products via the Comms link.

The following automatic setup procedure should be used to set up the Comms correctly between several products:

- Connect one of the DIN COMMS sockets on the back panel of the Ultra Digital to Analogue Converter to one of the COMMS sockets on another G Series, 500 Series, or 800 Series unit, using the Comms leads provided with the products.

The sequence in which you connect the units is not important.

- Switch all the units to standby.
- Press **Clear** (remote).

Each unit will display: **Auto**

One unit will then be designated as the controller.

The display shows: **Controller**

All the other units will be configured as non-controllers.

The displays show: **Not Con.**

If for any reason the automatic setup does not work, make sure you are operating the remote from a position where all the units can receive the infra-red, and try again.

If this fails:

- Restore the default operation by selecting one of the standard types; see *Choosing a standard setting*, page 24.

Do not, under any circumstances, connect any equipment other than Meridian G Series, 500 Series, or 800 Series to any socket marked COMMS on the back of the product.

Configuring the Ultra Digital to Analogue Converter

This chapter explains how to set up the Ultra Digital to Analogue Converter for most standard configurations of your other equipment, using just the front-panel controls and MSR+.

For complete control over all aspects of the Ultra Digital to Analogue Converter's configuration it is recommended that you use the Meridian Configuration Program; for more information see *Installing the Meridian Configuration Application*, page 28.



Choosing a standard setting

The Ultra Digital to Analogue Converter provides two standard settings, called Types, which configure all settings to standard configurations.

These standard Types are shown in the following table:

Type	Label	Description
1	Fixed	Fixed output, for use with a preamplifier.
2	Variable	Variable output, for use with power amplifiers or analogue speakers.

In addition, your installer may have provided one or more named User Types, with settings appropriate to the configuration of equipment when your Ultra Digital to Analogue Converter was installed.

You can reset the configuration to any of these Types to restore it to the state it was in when it was installed.

Note: Selecting a Type will clear any configuration changes you have made.

To select a standard setting

Warning: this procedure will reset any configuration changes you have made.

- Switch off any power amplifiers that are connected to the Ultra Digital to Analogue Converter.
- Put the Ultra Digital to Analogue Converter into standby by pressing **Off** (front panel or remote).
- Press and hold down **Volume +** (under the front panel).

The display shows:

```
Type in... 3
```

- Keep holding down **Volume +** for a further three seconds.

The display shows:

```
Type- please wait.
```

Then after a short delay the display shows the current Type.

For example:

```
Type 1 Fixed
```

- Press **▲** or **▼** on the front panel (or **Volume +** or **Volume +** under the front panel) to change the Type number.

The display shows:

```
Typing, please wait.
```

Either:

- Press **Setup** (under the front panel) to skip directly to front panel setup mode; see *Setup parameters*, page 25.

Or:

- Wait for one second, and then put the Ultra Digital to Analogue Converter into standby by pressing **Off** (front panel or remote).
- Switch on again to use the standard settings you have selected.

Setup parameters

To enter front panel setup mode

- Put the Ultra Digital to Analogue Converter into standby by pressing **Off** (front panel or remote).
- Press and hold down **Setup** (under the front panel).

The display shows:

- Keep holding down **Setup** for a further three seconds.

When the countdown finishes the display will show the first of the setup menus.

For example:

To use the setup menus

- Press ◀ or ▶ (under the front panel) until the display shows the parameter you want to change.

For example:

- Press ▲ or ▼ (under the front panel) to change the parameter.

To exit from setup mode

- Press **Off** (front panel or remote).
- Switch on again to use the setup parameters you have selected.

The following table gives a list of the setup parameters:

Parameter	Range	Default	Notes
IR	Auto, Controller, Not Controller	Auto	See <i>To connect to other G Series or 800 Series equipment</i> , page 22.
Startup Volume	LV or 25 to 87	Last Valid	Only available if Output is Variable . See <i>To set the startup volume</i> , page 26.
Output	Fixed, Variable		See <i>To set the output mode</i> , page 26.
Gain Offset	Show, Hide	Hide	Only available if Output is Fixed . See <i>To show the gain offset menu</i> , page 27.
Diagnostics	Show, Hide	Hide	To help diagnose technical issues.

Setting the startup volume and output mode

When you switch the Ultra Digital to Analogue Converter on from standby you can choose to set the volume to a fixed value, or to the last value it was set to.

The output mode determines whether the Ultra Digital to Analogue Converter provides the volume control for the analogue outputs.

The Startup Volume option is only applicable if you have set up the Ultra Digital to Analogue Converter with variable output.

To set the startup volume

- Press ◀ or ▶ (under the front panel) until the display shows the startup volume setting.

For example:

Startup Volume 25

- Press ▲ or ▼ (under the front panel) to change the parameter.

You can set it to any value between 25 and 87, or LV (Last Valid) which restores the volume to the last value it was set to.

For example:

Startup Volume LV

To set the output mode

The output mode determines whether the Ultra Digital to Analogue Converter provides volume control.

- Press ◀ or ▶ (under the front panel) until the display shows the current output setting.

For example:

Output Fixed

- Press ▲ or ▼ (under the front panel) to change the setting.

For example:

Output Variable

Set **Output to Fixed** if the Ultra Digital to Analogue Converter is connected to an analogue preamplifier or integrated amplifier.

Set **Output to Variable** if the Ultra Digital to Analogue Converter is connected directly to a power amplifier.

Adding a gain offset

If the Ultra Digital to Analogue Converter is set up in fixed output mode you can use the gain offset setting to adjust the level of the outputs, to compensate for preamplifiers that require a lower input signal level.

The range of adjustment is 0dB to -10dB.

Once you have adjusted the gain offset you can hide the menu to avoid accidental changes.

The gain offset is stored permanently, and is used for all sources whether the menu is shown or hidden.

To show the gain offset menu

In setup mode:

- Press ◀ or ▶ (under the front panel) until the display shows the current setting.

For example:

A screenshot of a digital display showing the text "Gain Offset" on the left and "Hide" on the right, both in a monospaced font.

- Press ▲ or ▼ (under the front panel) to change the setting.

For example:

A screenshot of a digital display showing the text "Gain Offset" on the left and "Show" on the right, both in a monospaced font.

To change the gain offset

In normal mode:

- Press ◀ or ▶ (remote or under the front panel) until the display shows the current gain offset.

For example:

A screenshot of a digital display showing the text "PVR Offset" on the left and "0dB" on the right, both in a monospaced font.

- Press ▲ or ▼ (remote or under the front panel) to adjust the offset.

For example:

A screenshot of a digital display showing the text "PVR Offset" on the left and "-3dB" on the right, both in a monospaced font.

Installing the Meridian Configuration Application

The Meridian Configuration Application can be used to further personalise the Ultra Digital to Analogue Converter to your requirements, and create a backup of your settings. It is available for free download from our website:

www.meridian-audio.com

Requirements

To use the Meridian Configuration Application you need:

- A computer running Windows 95, 98, 2000, NT 4, ME, XP, Vista, Windows 7, Windows 8, or Windows 10.
- 20Mbytes of free disk space.
- A 9-pin serial port or suitable serial adaptor (such as USB-Serial, PC Card, etc).
- An RS232 null-modem cable.
- A mouse or similar pointing device – the application cannot be operated solely from the keyboard.

The Meridian Configuration Application communicates with the products you are setting up via a serial cable.

You can connect the product to a 9-pin serial port on the computer.

Alternatively, a USB-to-serial converter, available from most computer retailers, can be used to connect between the product and a USB port on the computer.

Installation

To install the application you will need a computer that is connected to the Internet.

- Type the following URL into the address bar of a Web browser:

www.meridian-audio.com/download/setup.exe

If you are asked whether to Run or Save the application:

- Click **Run**.

Otherwise:

- Run the setup.exe application once it has downloaded.

The **Setup** application's **Welcome** page will be displayed.

- Follow the instructions.

On the **Preferences** page:

- Leave **Install for all users** selected, unless you want to restrict use of the application to yourself on a multi-user machine.

User guide

You can download an electronic copy of the *Meridian Configuration Program Guide* in Acrobat format from our website:

www.meridian-audio.com

Follow the links to the Ultra Digital to Analogue Converter support section where you will find this and other useful documentation.

Index

A

accessories 16
audio settings, storing 12

B

back panel connections 16
balance, changing 11
balanced outputs 17
bass, changing 11
brightness, front-panel display 14

C

Comms, connecting 17, 22
communications connections 17
computer, connecting to 19
configuring 23
connecting
 to a computer 19
 to a digital source 18
 to a power amplifier 20
 to a preamplifier 21
 to Meridian equipment 22
contrast, front-panel display 14

D

digital inputs 17
digital source, connecting to 18
display, front panel 14

F

front panel keys 6

G

gain offset
 changing 27
 showing or hiding the menu 27

I

inputs 17
 digital 17
 network 17
 optical 17
 SpeakerLink 17
 USB 17

L

LipSync 13

M

Meridian Configuration Application 28
Meridian System Remote keys 7
MQA 2, 14
muting the sound 10

N

network input 17

O

optical inputs 17
output mode, specifying 26
outputs 17
 balanced 17
 unbalanced 17

P

power amplifier, connecting to 20

R

registration iv
RS232 connection 17

S

safety warnings ii
setup mode 25
Setup parameters 25
Sooloos, using 9
Sooloos network connection 17
sound, muting 10
sources 9
 selecting 9
SpeakerLink input 17
specifications 3
standard settings, selecting 24
standby
 switching on from 8
 switching to 8
startup volume 10
startup volume, setting 26
storing the audio settings 12
switching on and off 8

T

treble, changing 11
trigger outputs 17
Types 24

U

unbalanced outputs 17

unpacking 16

USB, connecting 19

USB input 17

V

volume, adjusting 10

