

PREMIUM-KIT (PW-662 , PL-664)

- PANNELLO FRONTALE IN LEGNO
- FRONT WOODEN PANEL
- PANNEAU DE FAÇADE EN BOIS
- HOLZFRONT

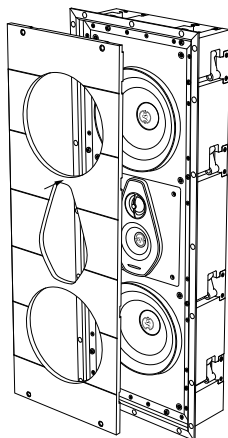

- RIMOZIONE DEL PANNELLO IN LEGNO
- REMOVING THE WOODEN PANEL
- RETRAIT DU PANNEAU EN BOIS
- AUSBAU DES HOLZÜANEELS

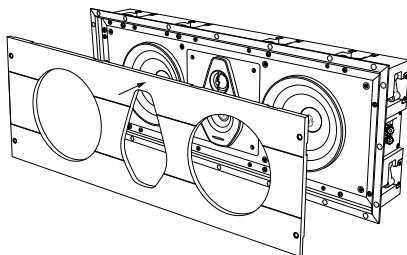
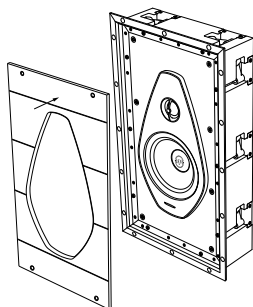
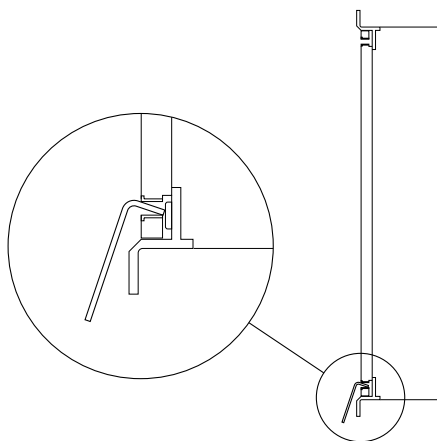

Usare un qualsiasi attrezzo, ad esempio una chiave a brugola come in figura, per fare delicatamente leva e sfilare il pannello in legno.

Use any tool, for example an Allen wrench as in the figure, to delicately lever and slide the wooden panel out.

Utiliser n'importe quel outil, comme par exemple une clé Allen comme indiqué sur la figure, pour faire délicatement levier et retirer le panneau en bois.

Mit einem beliebigen Werkzeug, beispielsweise einem Inbusschlüssel, wie abgebildet eine leichte Hebelwirkung ausüben und das Holzpaneel abziehen.



- MASCHERA TENDIFILO
- STRING GRILLE
- GRILLE EN CORDES TENDUES
- DRAHTSPANN-BLENDE

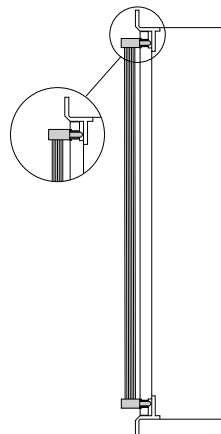
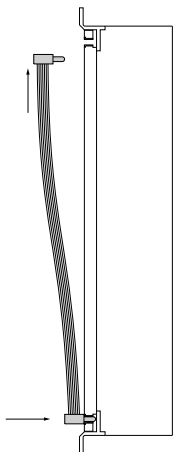
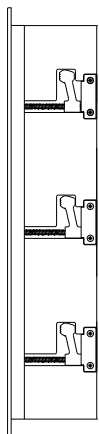

- CORNICE VERNICIABILE
- PAINTABLE FRAME
- CADRE (PEINTURE POSSIBLE)
- LACKIERBARER RAHMEN

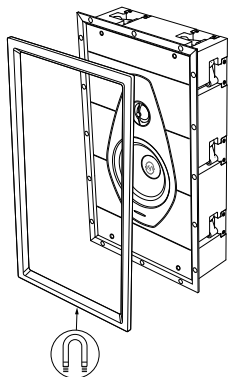

- La cornice può essere verniciata a piacere. Si consiglia di procedere alla verniciatura in luogo aperto e lontano dal diffusore.
- The frame can be painted as desired. Painting is recommended outdoors and away from the speaker.
- Le cadre peut être peint à votre guise. Nous conseillons de réaliser les travaux de peinture dans un endroit ouvert et éloigné de l'enceinte.
- Der Rahmen kann nach Belieben lackiert werden. Es wird geraten, die Lackierung im Freien und fern vom Lautsprecher vorzunehmen.