



TRIANGLE



Owner's manual & Warranty



# CONTENTS

---

<b>P.4</b>	<b>USER MANUAL - ENGLISH</b>
<i>p.5</i>	1. Installation precautions / Warnings
<i>p.6</i>	2. Unpacking
<i>p.7</i>	3. Description of the speakers
<i>p.8</i>	4. Description of the Stereo Hub
<i>p.9</i>	5. Description of the remote
<i>p.10</i>	6. Initial system startup
<i>p.11</i>	A. Setting up the Stereo Hub
<i>p.12</i>	B. Setting up the speakers
<i>p.13</i>	7. Starting up the system after a reset
<i>p.14</i>	A. Setting up the Stereo Hub
<i>p.15</i>	B. Remote control pairing
<i>p.16</i>	C. Speakers pairing
<i>p.18</i>	8. Connecting the Stereo Hub to the Wi-Fi via Google Home
<i>p.20</i>	9. The TRIANGLE CAPELLA app
<i>p.21</i>	A. Description
<i>p.22</i>	B. Settings
<i>p.23</i>	C. Speaker Settings
<i>p.26</i>	D. EQ functions introduction
<i>p.27</i>	E. EQ -Description
<i>p.28</i>	F. ROOM EQ
<i>p.32</i>	G. MANUAL EQ
<i>p.42</i>	10. Connecting sources to the Stereo Hub
<i>p.43</i>	A. Wi-Fi / Streaming service
<i>p.59</i>	B. Bluetooth
<i>p.60</i>	C. HDMI
<i>p.61</i>	D. USB
<i>p.62</i>	E. Optique / Coaxial / Jack 3.5
<i>p.63</i>	F. RCA
<i>p.64</i>	11. Connecting sources without the Stereo Hub
<i>p.64</i>	A. RCA
<i>p.65</i>	B. WiSA
<i>p.66</i>	12. APPENDIX
<i>p.67</i>	APPENDIX 1: Connection via an IP Address
<i>p.69</i>	APPENDIX 2: Zen microphone
<i>p.71</i>	APPENDIX 3: Stereo settings using the remote control
<b>P.72</b>	<b>TECHNICAL INFORMATIONS</b>
<b>P.73</b>	<b>SAFETY INSTRUCTIONS</b>
<b>P.74</b>	<b>GARANTIE</b>

# USER MANUAL

---

# ENGLISH

The TRIANGLE team appreciates the trust you place in our brand.

For optimal use and perfect sound reproduction of your CAPELLA system, please read the instructions in this manual.

## **CAPELLA System**

Models:

*CAPELLA: TEA8\_BL, TEA8\_BU, TEA8\_BW, TEA8\_BX, TEA8\_BY, TEA8\_BZ, TEA8\_CA*

# 1. INSTALLATION PRECAUTIONS / WARNINGS

## INSTALLATION PRECAUTIONS

### BEFORE THE INSTALLATION

Before making any connections, make sure the speakers and the Stereo Hub are switched off. Always disconnect power cables from the mains before removing or connecting cables. Do not plug them back in before all connections are made.

### MOVING THE SYSTEM

Always remove the power cord and disconnect the cables between all components when moving the device. This will prevent a short-circuit or the damage to the plugs or connection cables.

### BEFORE SWITCHING ON THE DEVICE

Check one last time if all the connections are correct.

### LOCATIONS TO AVOID

Install your speakers in a temperate place and avoid humid locations or direct sunlight.

### RECYCLING

Protection of the environment: your products contain valuable materials which can be recovered or recycled. Take them to the appropriate collection points.



### WARNING

Always use the product in an environment where the temperature is between -10°C and 40°C, otherwise your product may be damaged.

For the following devices:

Product Name: CAPELLA Brand: TRIANGLE

TRIANGLE Hi-Fi (Email: [capella@trianglehifi.com](mailto:capella@trianglehifi.com)) declares that this CAPELLA product, Models: CAPELLA: TEA8\_BL, TEA8\_BU, TEA8\_BW, TEA8\_BX, TEA8\_BY, TEA8\_BZ, TEA8\_CA

Tested in accordance with the Radio Equipment Regulations 2017 (SI 2017 No. 1206, as amended by SI 2019 No. 696).



The full text of the UK Declaration of Conformity is available here: <https://www.trianglehifi.fr/pages/declaration-conformite-uk>

The RF distance between body and product is 0mm.

Bluetooth version: Bluetooth V4.2 (Only EDR) Frequency range: 2402-2480MHz

Maximum RF output level : 4dBm (EIRP)

2.4GHz

Frequency range: 2464MHz Receiving

## 2. UNPACKING

Remove the speakers, grilles and accessory box from the packaging. If you notice any defects in one of the elements, please get in touch with your reseller.

Before disposing of the packaging\*, make sure there is nothing left inside.

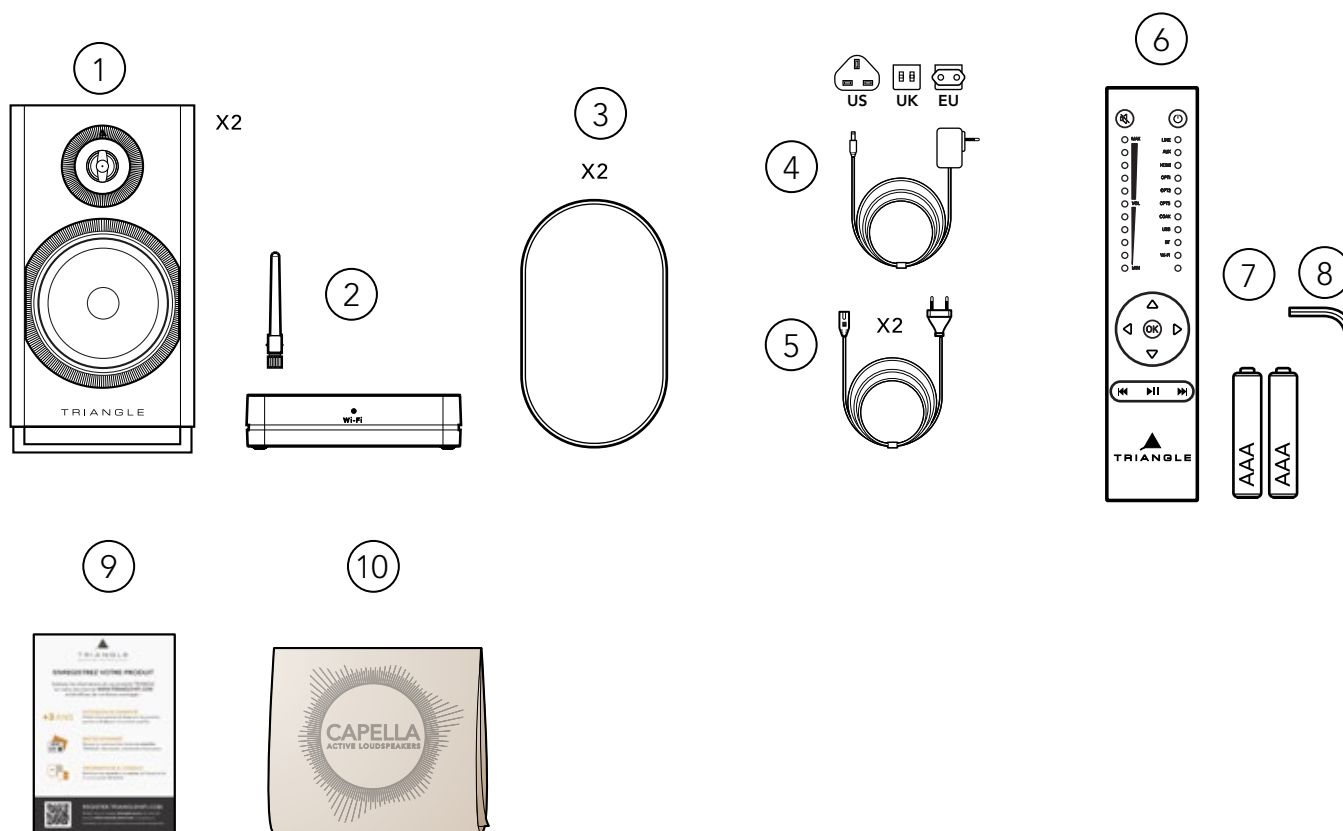

### Includes :

1. 2 x CAPELLA speakers.
2. 1 x Stereo Hub with its antenna.
3. 2 x Magnetic protection grilles.
4. 1 x Power cable for the Stereo Hub (3 adapters supplied: EU, UK, US)..
5. 2 x power cables for the speakers.
6. 1 x Remote control.
7. 2 x AAA batteries for remote control.
8. 1 x Allen key for remote control battery change.
9. 1 x Registration coupon.
10. 1 x Cleaning cloth for speaker maintenance.



#### \* KEEP ORIGINAL PACKAGING

If you need support or wish to return your product, please ship it in the original packaging with all accessories. In case of damage due to incorrect packaging, your dealer will not guarantee that the product will be accepted.

### 3. DESCRIPTION OF THE SPEAKERS

The Capella active speakers each feature their own amplification (2x50 watts per speaker). This means they can receive music from any WiSA transmitter at a resolution of 24bits/96Khz.

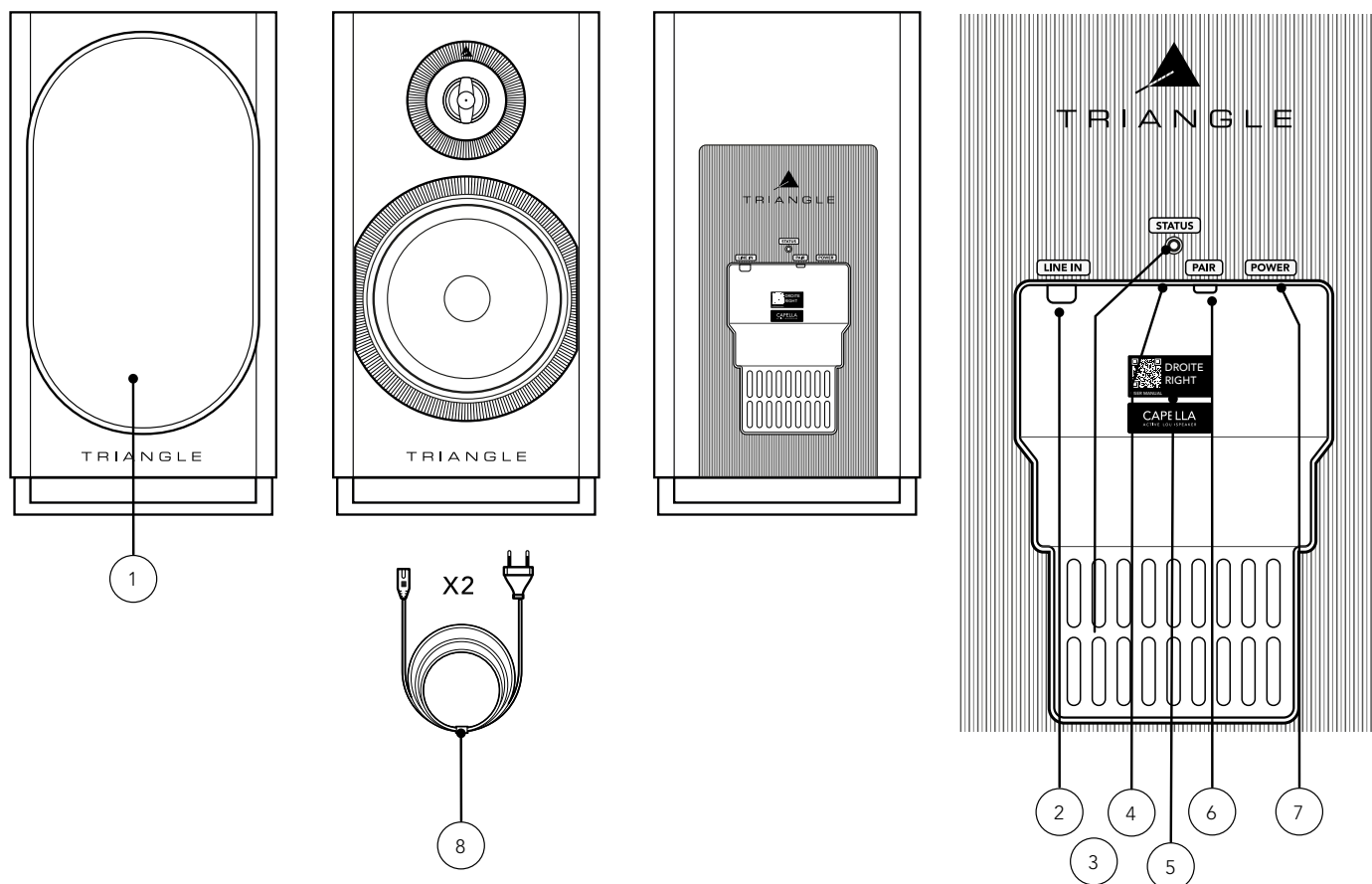

1. Magnetic protection grille\* (1 pair).
2. RCA (left or right depending on speaker assignment).
3. Service & product update connector.
4. LED indicator:
  - Blue LED: Startup sequence.
  - Flashing orange LED: WiSA pairing.
  - Solid orange LED: Speaker connected to the Stereo Hub or another WiSA source.
  - Red LED: Standby.
  - Green LED: Connection of a preamplified source to the RCA jack.
5. Left or right speaker sticker and QR code to access user manual.
6. Pairing button :
  - Pressing and holding for 4 seconds: WiSA pairing with the Stereo Hub or another WiSA source.
  - Pressing and holding for 10 seconds: Resetting the speaker.
7. Power Connector.
8. Power cable.

\* For optimal use and perfect sound reproduction, it is recommended to remove the magnetic grilles when listening.

## 4. DESCRIPTION OF THE STEREO HUB

The Stereo Hub is not only a wireless audio transmitter, but also a Hi-Fi preamplifier streamer. It features WiSA wireless technology, allowing high-resolution transmission from your source to your speakers, with no noticeable latency.

Connect a wide range of sources to the back of the device or use the Stereo Hub's streamer function with Google Cast / Apple Airplay / Spotify Connect / Roon Ready / DLNA / Bluetooth compatibility.

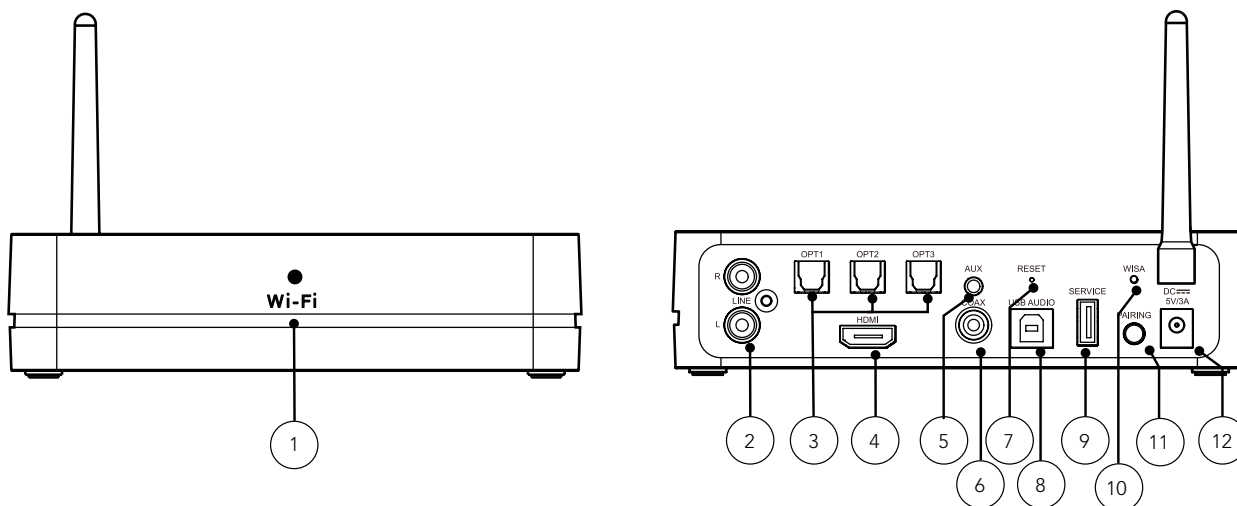

1. Wi-Fi LED indicator:
  - Solid white LED: Connected to the network.
  - Slow flashing white LED: Startup sequence.
  - Fast flashing white LED: Wi-Fi configuration mode.
  - Irregular flashing white LED: Updating Software.
  - Solid green LED: Connected to Spotify Connect.
2. RCA input.
3. 3 x Optical input.
4. HDMI in (ARC).
5. Aux/Optical input.
6. Coaxial digital input.
7. Factory reset.
8. USB-B input.
9. USB to update the Stereo Hub.
10. WiSA LED indicator:
  - Solid white LED: Stereo Hub paired to the Capella speakers.
  - Slow flashing white LED: WiSA pairing mode.
  - Fast flashing white LED: Remote control pairing mode.
11. Pairing button:
  - Simple pressure: WiSA pairing mode.
  - Pressing and holding for 4 seconds: Remote control pairing mode.
12. Power Connector

### AUTO STANDBY

If no signal is received for 20 minutes, the Stereo Hub will automatically switch to standby. It will automatically switch back on when it receives a signal again. Startup takes about 8 seconds.

Please note: when using Optical / RCA / Coaxial / Auxiliary or USB sources, the standby output will default to the source used at the time of standby.



## 5. DESCRIPTION OF THE REMOTE

The remote control supplied with your CAPELLA system operates via radio frequency. You do not need to point it towards the Stereo Hub to control it. It has a range of 15 meters, even across obstacles. Featuring a motion sensor, you can visually check the sound level and the selected source

Remote control pairing - See page 15 or 25 depending on the method used.

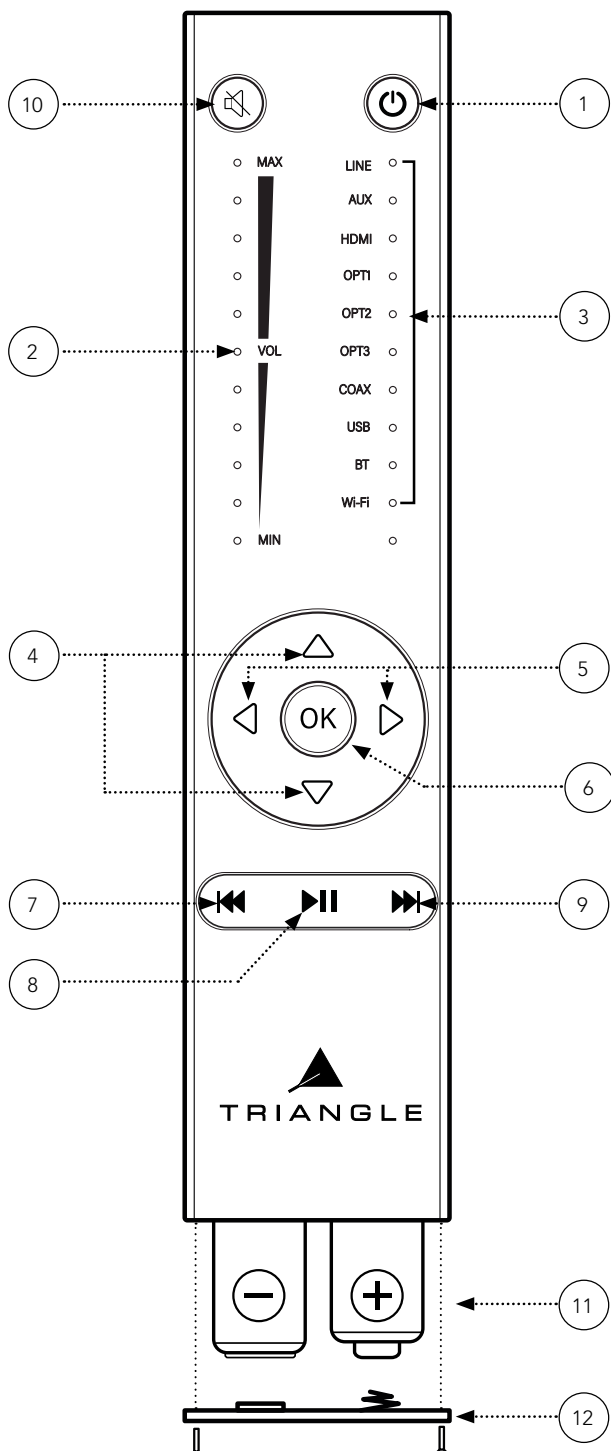

1. Power on/standby
2. Volume indicator via LEDs
3. Source indicator via LED
4. Volume level up/down
5. Source selection
6. Validation
7. Previous track\*

\* Press and hold for 3 seconds to hide Bluetooth visibility.

8. Play/Pause\*

\* Previous/playback/next functions are only available with a Wi-Fi / Bluetooth source.

9. Next Track\*

\* Press and hold for 3 seconds to make Bluetooth visible.

10. Muting\*

\* Press and hold for 5 seconds to toggle

the volume setting on/off on the selected input.

11. AAA batteries (2x)

12. Battery protection cover

REMOTE Models:

CAPELLA: TEA8\_BL, TEA8\_BU,  
TEA8\_BW, TEA8\_BX, TEA8\_BY,  
TEA8\_BZ, TEA8\_CA

Frequency range:

2464MHz - 2.RF

## 6. 6. INITIAL SYSTEM STARTUP

To make setup as easy as possible, your CAPELLA system is already pre-configured.  
We have paired your remote control and speakers.

(If you have restored your system to factory settings, please go directly to page 13)

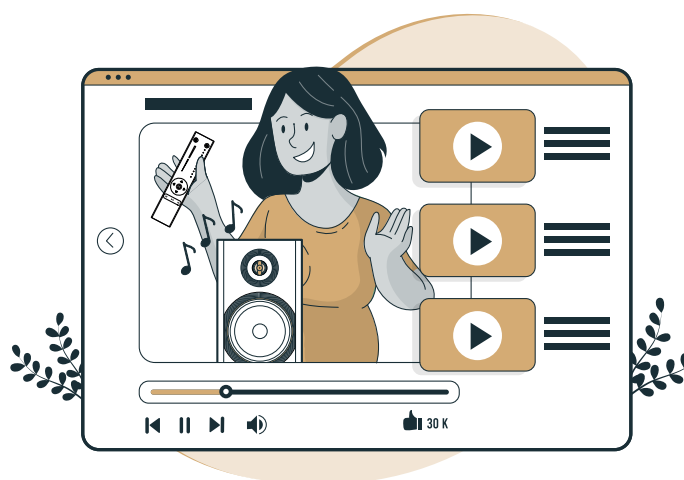

To assist you, a video of each installation step is available  
by scanning the QR code below :



## 6.A SETTING UP THE STEREO HUB

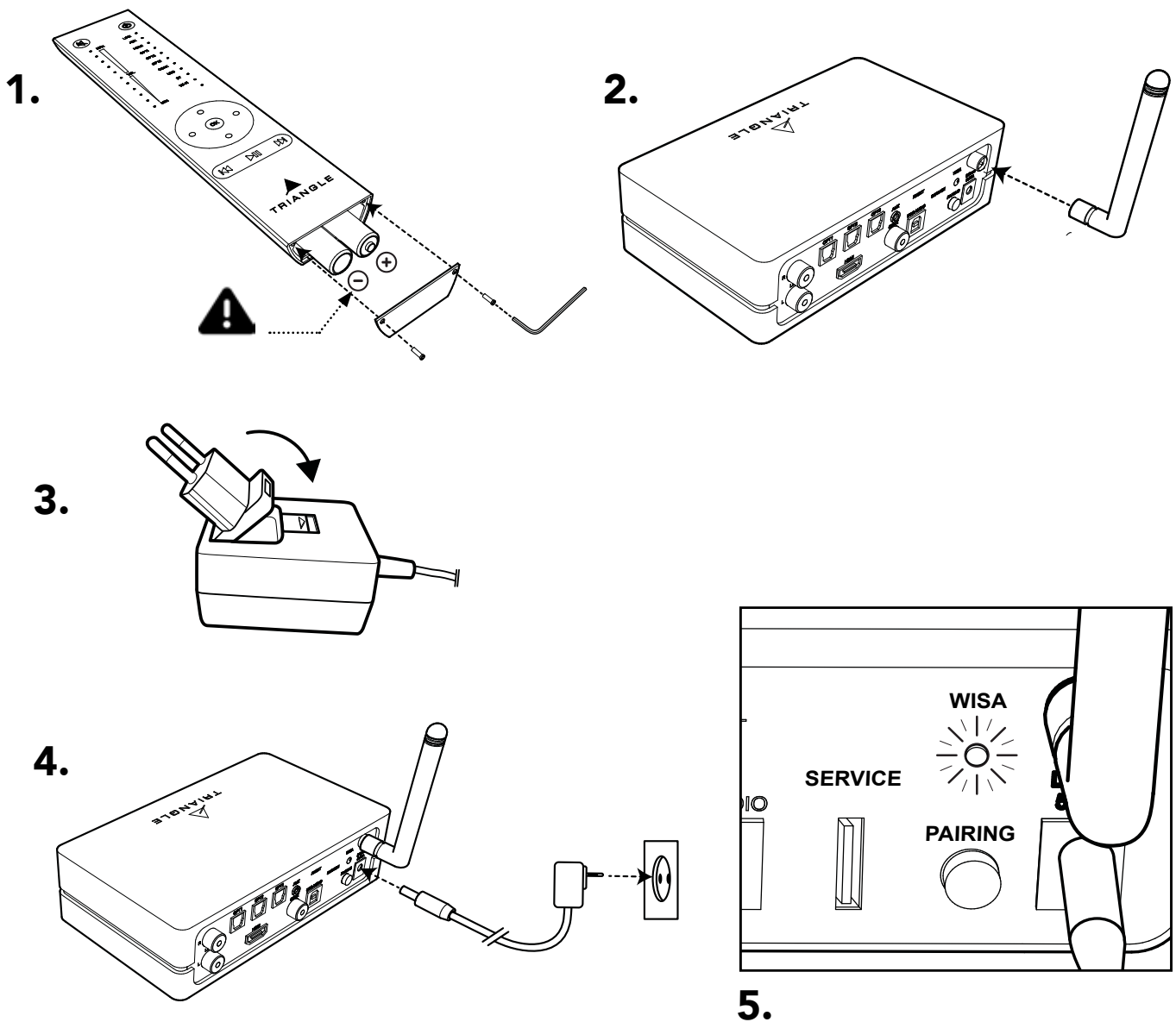

1. Place the batteries in your remote control using the supplied key. Ensure that the polarity is correct.

2. Screw the antenna on the Stereo Hub.

3. Select the right plug for your AC outlet.

4. Then Connect the power cable between your Stereo Hub and your AC outlet.

5. The Stereo Hub begins its startup sequence. Please wait until it is finished. This is how it works: the WiSA LED remains switched off for 50 seconds, then flashes for 20 seconds before switching off again. The end of the startup sequence is confirmed once the WiSA LED switches off.

6. The WiSA LED on the Stereo Hub should flash each time you press the remote control. Run a test to check pairing.

## 6.B SETTING UP THE SPEAKERS

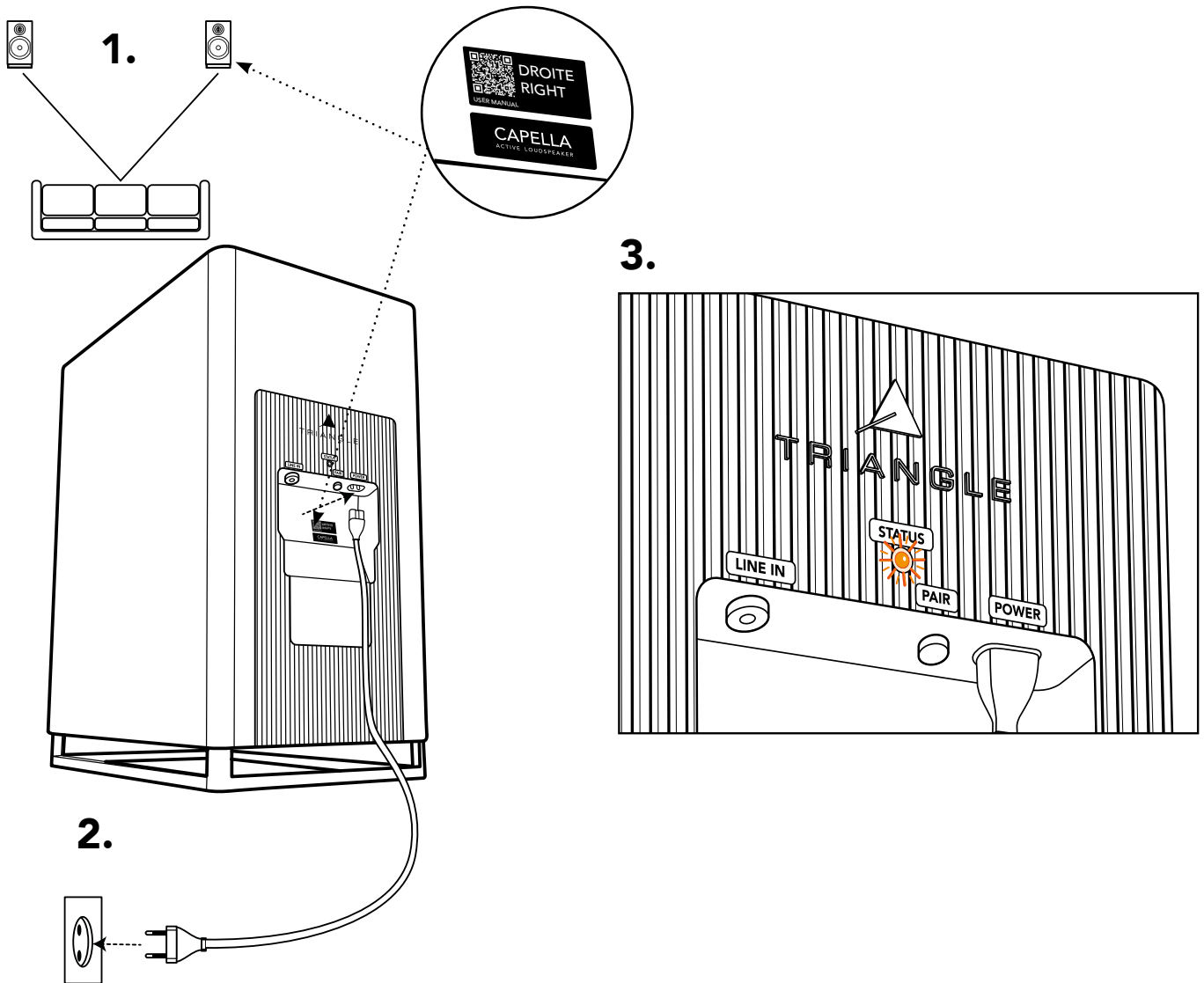

1. Refer to the label on the back of your speakers to find out whether they should be positioned to the left or right of your listening position.

2. Connect your speakers to your AC outlet using the supplied power cables.

3. Wait for the STATUS LED to glow solid orange, confirming the end of the startup sequence and the pairing of your speakers to the Stereo Hub.

4. Your system is now configured, and you can enjoy the Bluetooth\* source or any other physical source connected to the Stereo Hub. For optimal listening, however, we recommend that you connect your Stereo Hub to the Wi-Fi, then install the associated app to access all available settings and acoustic corrections.

Please turn to page 18.

\* See page 59 to learn more about the Bluetooth Setup

## 7. STARTING UP THE SYSTEM AFTER A RESET

Resetting your CAPELLA system requires a complete reconfiguration, please follow these steps carefully.

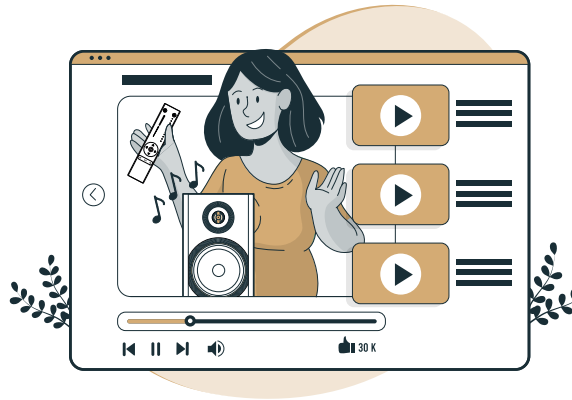

To assist you, a video of each installation step is available by scanning the QR code below:

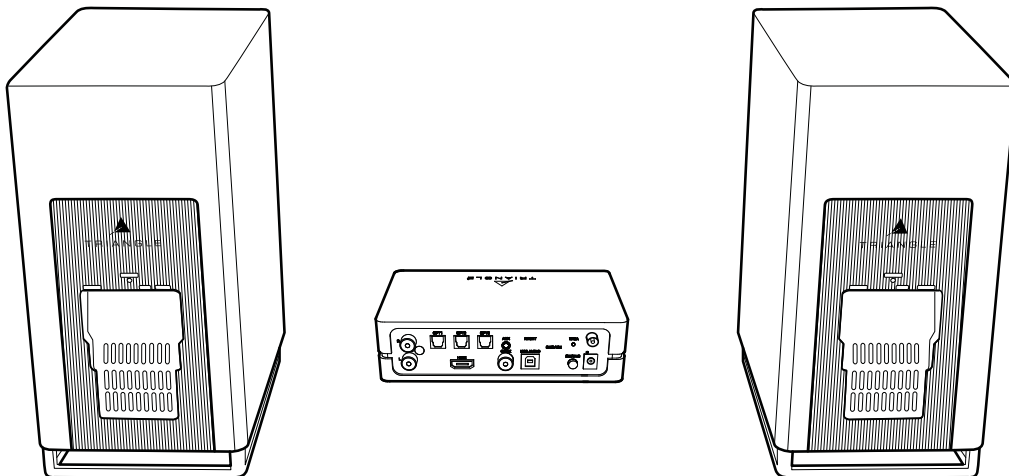

To make setup as easy as possible, we recommend you direct your Stereo Hub and speakers towards you, as shown in the image above.



**WARNING:** when you set up your Wi-Fi configuration, some of your configuration's protections, Wi-Fi repeaters or PLC boxes may block the installation. We recommend connecting to the Wi-Fi of the router from your Internet service provider with as few intermediaries as possible.

## 7.A SETTING UP THE STEREO HUB

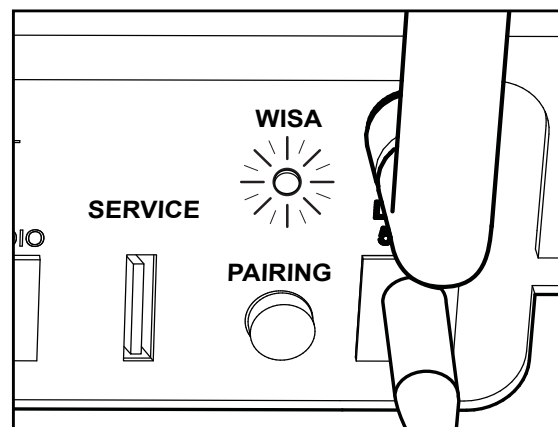
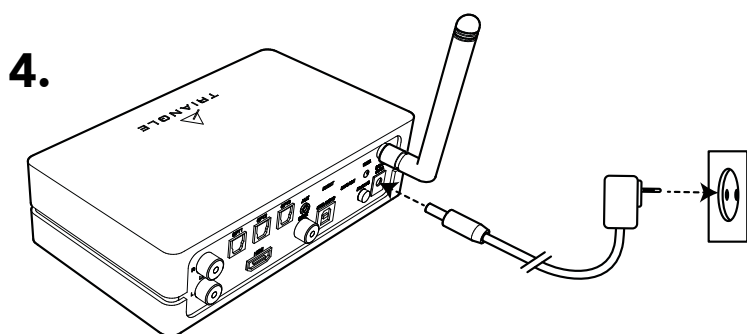
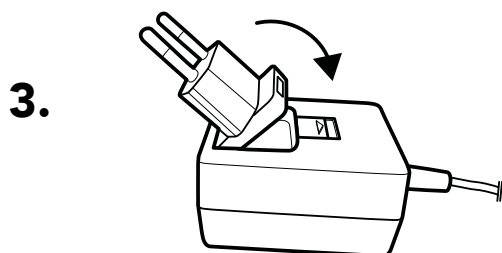
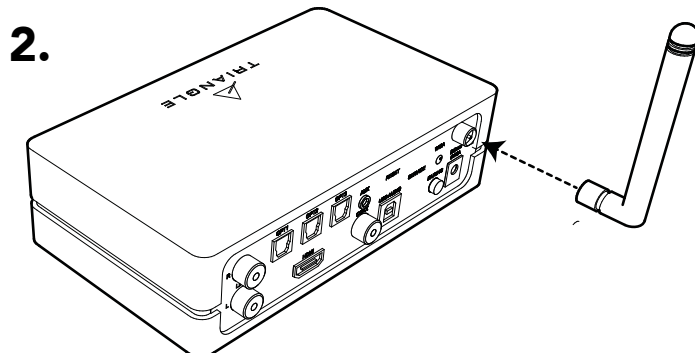
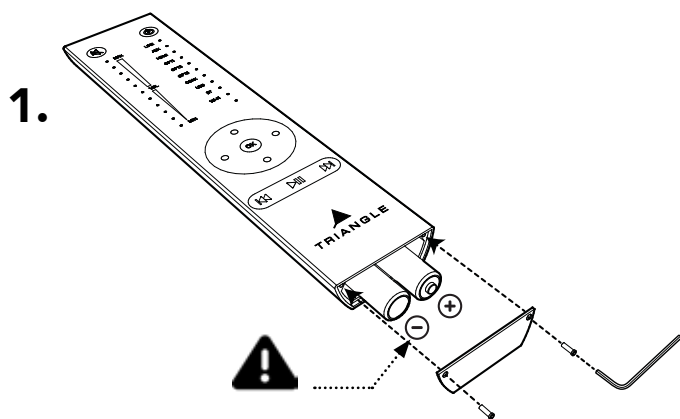

1. Place the batteries in your remote control using the supplied key. Ensure that the polarity is correct.

2. Screw the antenna on the Stereo Hub.

3. Select the right plug for your AC outlet.

4. Then connect the power cable between your Stereo Hub and your AC outlet

5. The Stereo Hub begins its startup sequence. Please wait until it is finished. This is how it works: the WiSA LED remains switched off for 50 seconds, then flashes for 20 seconds before switching off again. The end of the startup sequence is confirmed once the WiSA LED switches off. You can now pair your remote control.



Do not connect the speaker power cables at this time.

## 7.B REMOTE CONTROL PAIRING

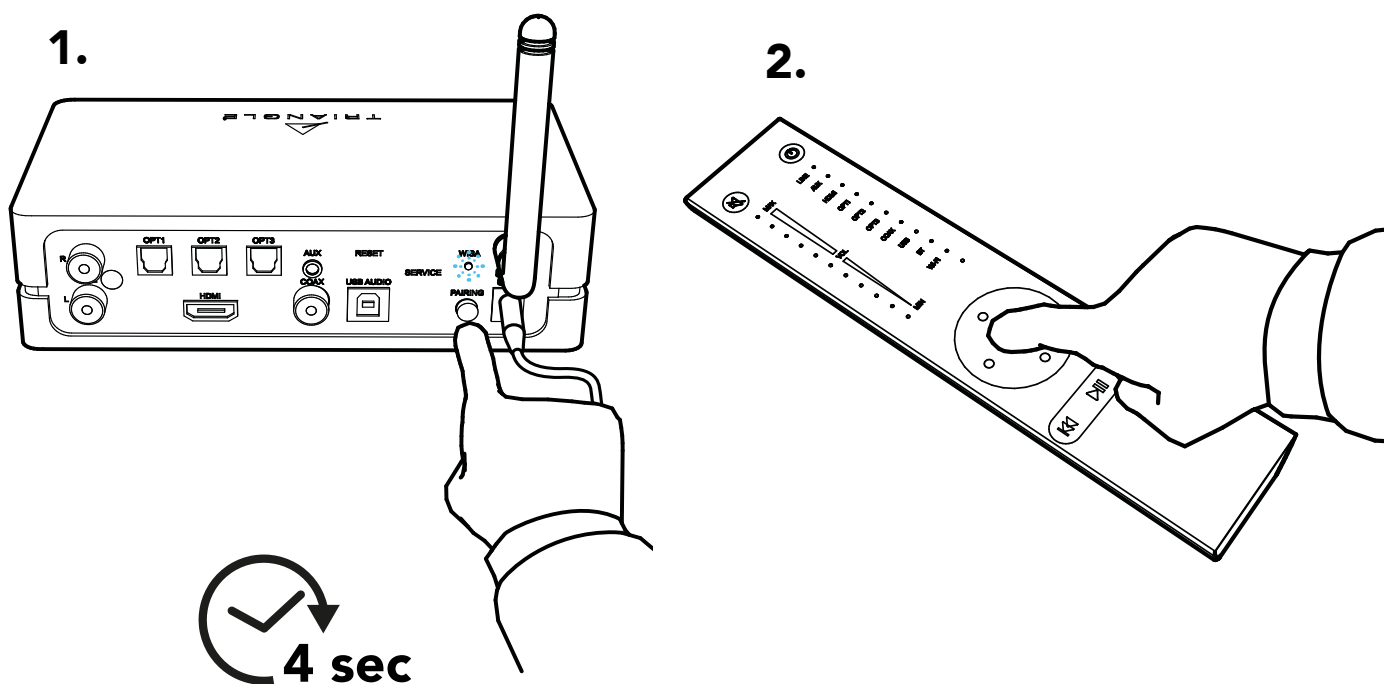

1. Press and hold the "PAIRING" button on the back of the Stereo Hub until the WiSA LED starts flashing rapidly. Release the button as soon as flashing starts.

2. Then press one of the remote

control buttons and wait for the WiSA LED to stop flashing. Your remote control and your Stereo Hub are paired.

Pairing is confirmed when the WiSA LED flashes each time you press a button on the remote control.



It is also possible to pair the remote control from the CAPELLA app (see page 24).



In the event of slow flashing or incorrect pairing, disconnect the power cable and return to step 7.A.4

## 7.C SPEAKERS PAIRING

1.

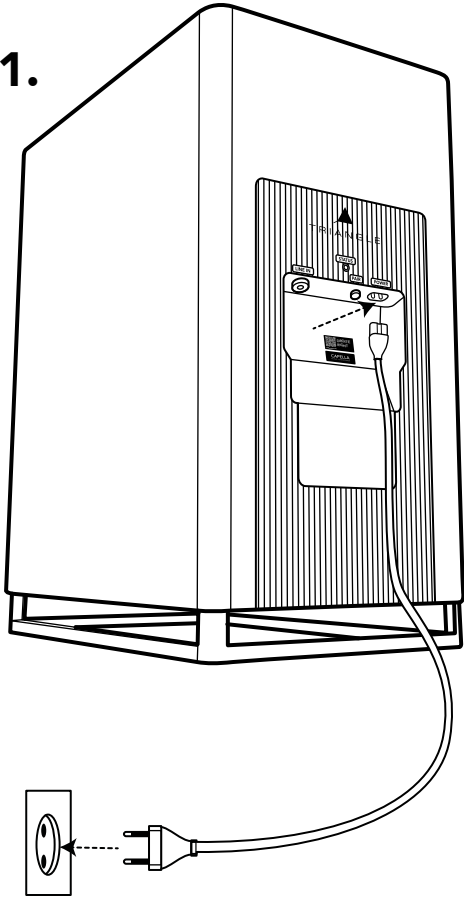

1. Connect your speakers to your AC outlet using the supplied power cables.

2. The speaker startup sequence begins. The STATUS LED flashes orange, then turns off and lights up blue for a moment, before turning

2.

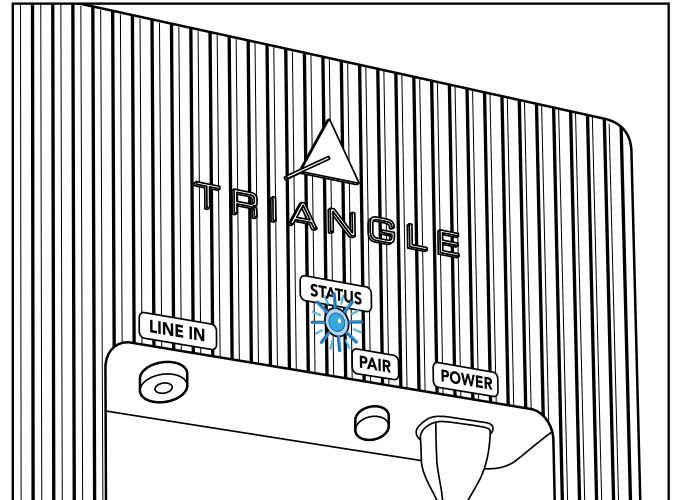

3.

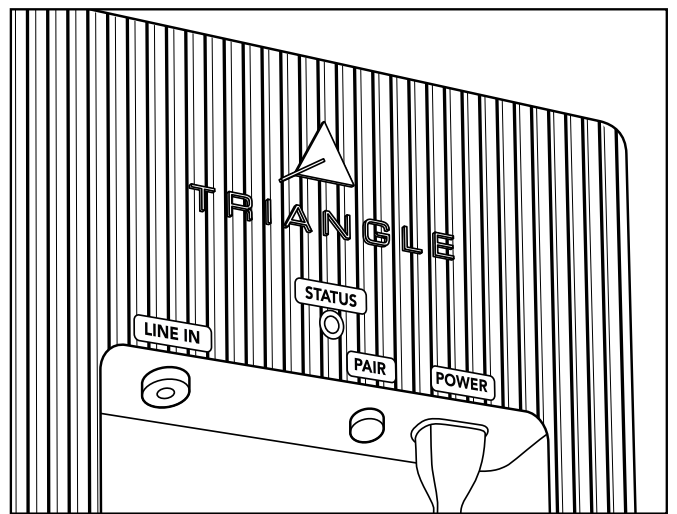

3. When the LED switches off, the startup sequence is complete.



## 7.C SPEAKERS PAIRING

4.

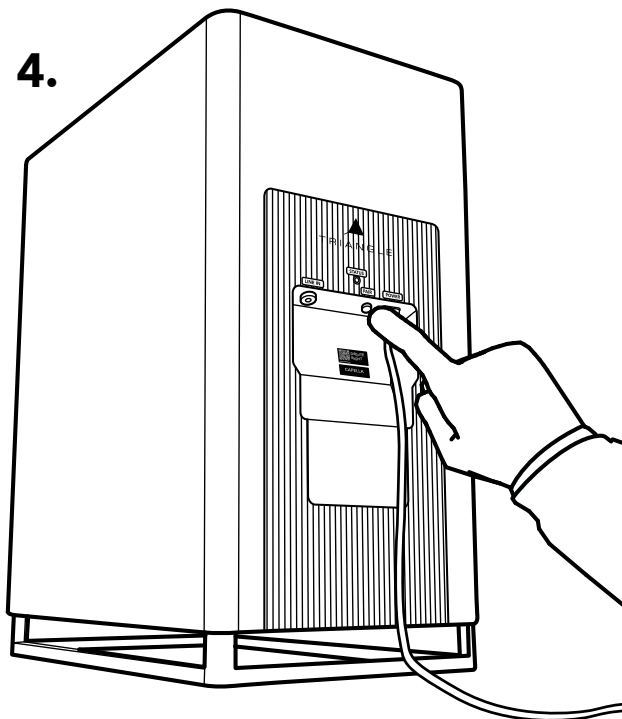

5.

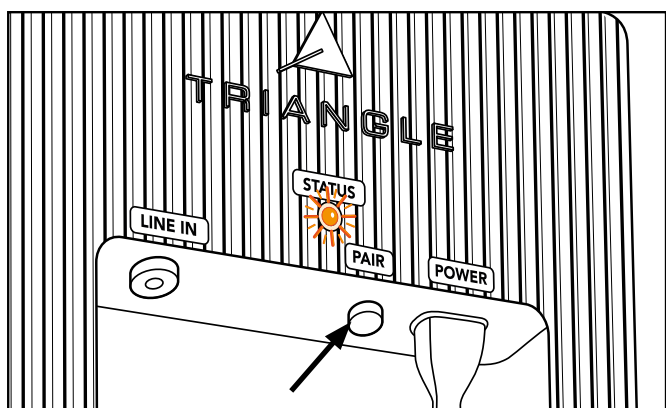
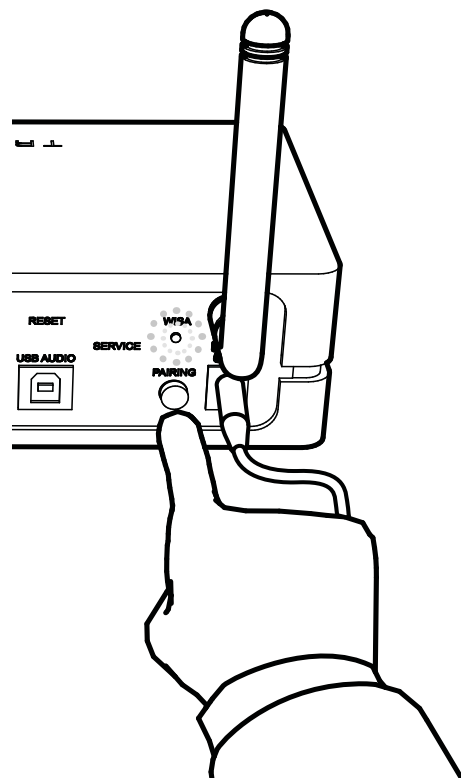

4. Press the "PAIR" button on each speaker for 3-4 seconds, then wait for the LEDs to start flashing orange rapidly

5. Briefly press the "PAIRING" button at the back of the Stereo Hub. The WiSA LED then starts flashing slowly.

6. Pairing is confirmed once the LEDs on all 3 devices (the Stereo Hub and the 2 speakers) are lit continuously.

7. Now position your speakers according to the left and right labels on the back. Then connect your Stereo Hub to the Wi-Fi.



If the STATUS LED turns blue again, unplug the speaker and go back to step 7.C.1

## 8. CONNECTING THE STEREO HUB TO THE WI-FI VIA GOOGLE

1.

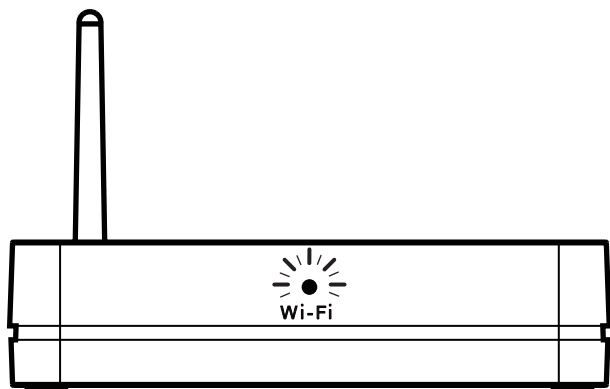

2.

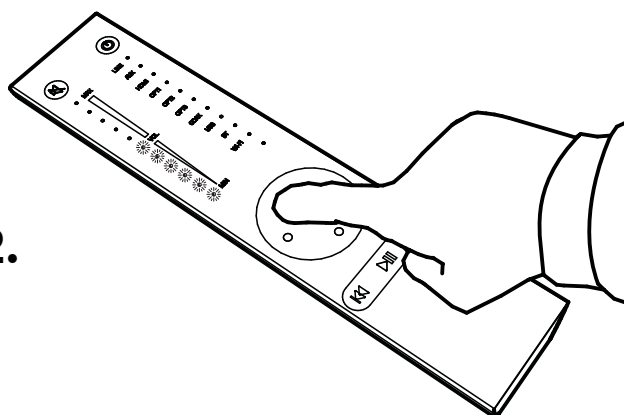

3.

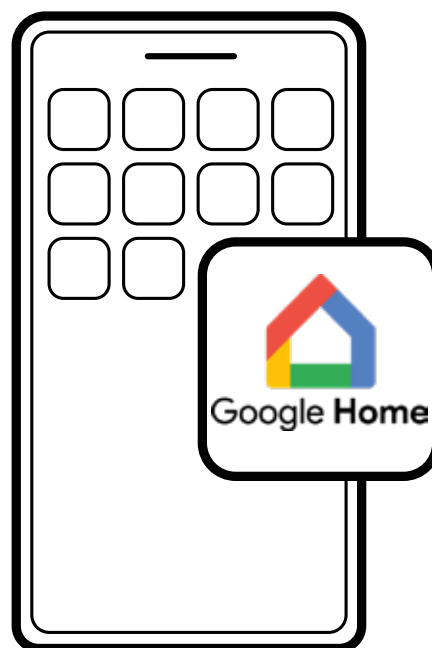

Apple



Android



1.The Wi-Fi LED on the front panel flashes rapidly, indicating that the "Wi-Fi configuration" mode has been activated.

2.Adjust the volume from your remote control by illuminating 6 LEDs.

\* If the Google Home app is not available in your area, a workaround is described in the appendix 1 p67.

3.Download the "Google Home"\* app on your smartphone or tablet and follow the instructions below. Configuration is complete once the Wi-Fi LED freezes (step 10).

## 8. CONNECTING THE STEREO HUB TO THE WI-FI VIA GOOGLE HOME

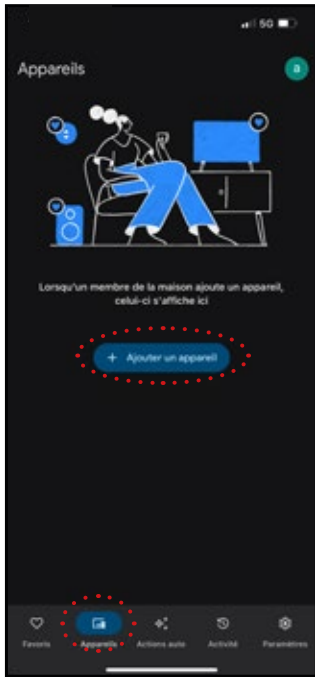

**3a.** Go to the "Devices" tab and click on "Add device".



**3b.** Choose "Google Nest or partner device".

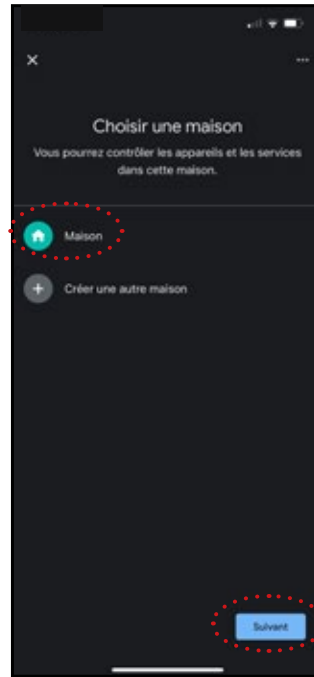

**3c.** Choose "Home" and click on "Next".

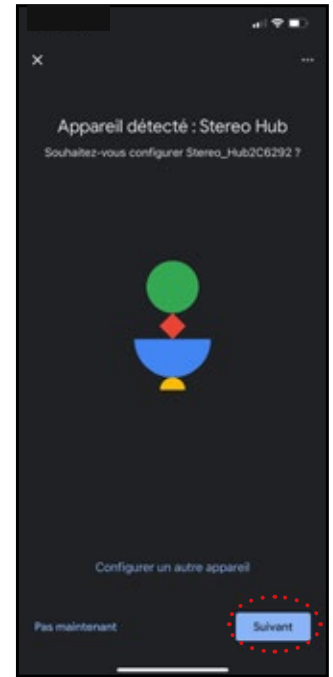

**3d.** Once the Stereo Hub is detected, click "Next".

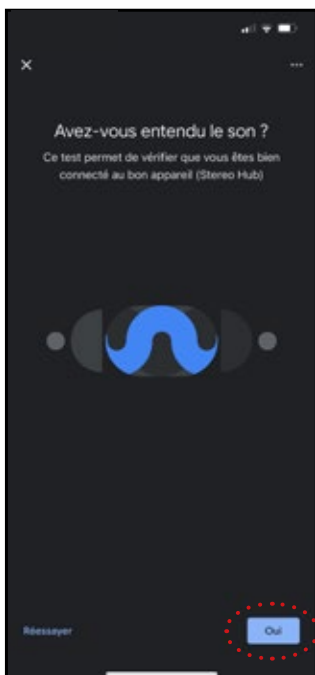

**3e.** When you hear a tone, click "Yes".

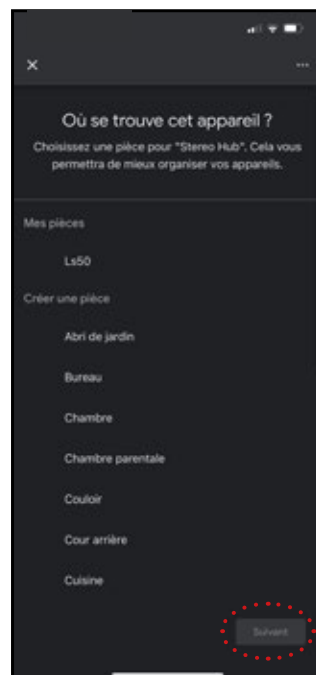

**3f.** This step determines the name of your system on your applications. You can choose a suggested room name, or name it as you wish by clicking on "Add a room". Then click "Next" to confirm.

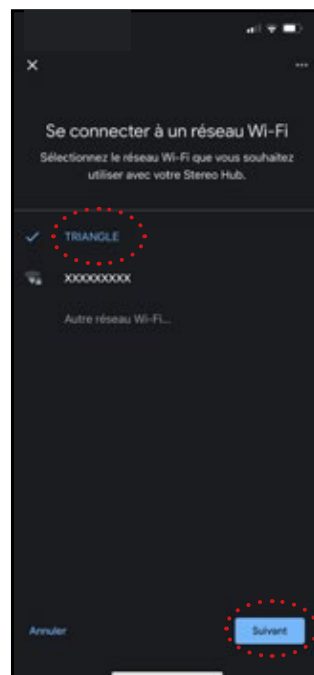

**3g.** Choose your Wi-Fi network. You may be asked for your Wi-Fi network password. Then click "Next".

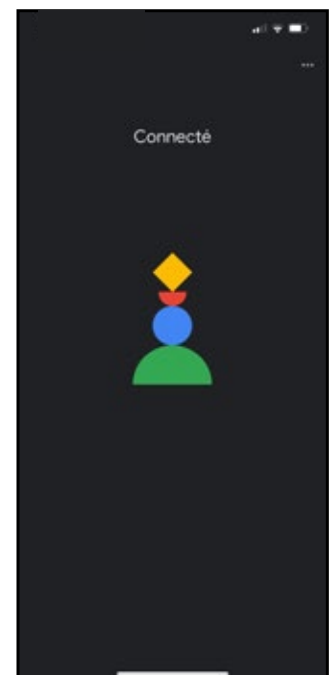

**3h.** Your CAPELLA system is now connected to your network.

Finish setup by installing the CAPELLA app on the next page.



If you do not hear any tone, click "Yes" as the test will be repeated later.

\* You need a Google Account to complete this step.

## 9. THE TRIANGLE CAPELLA APP

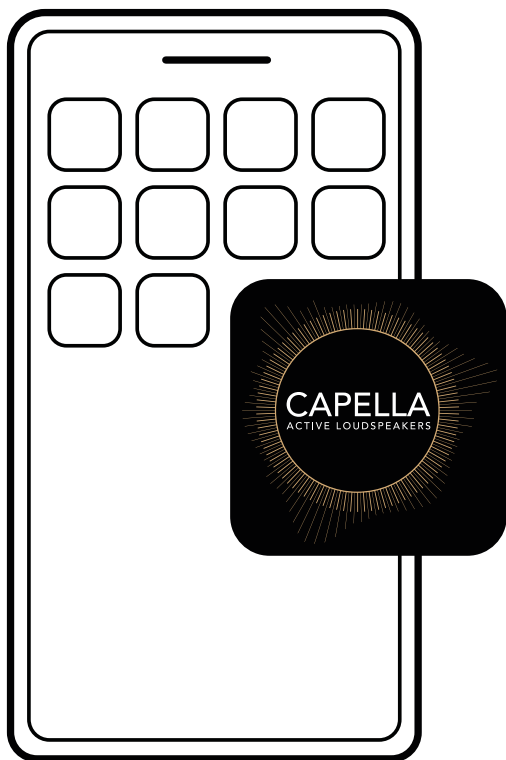

1. Go to the App Store (Apple) or Google Play Store (Android) and download the app : «TRIANGLE CAPELLA»

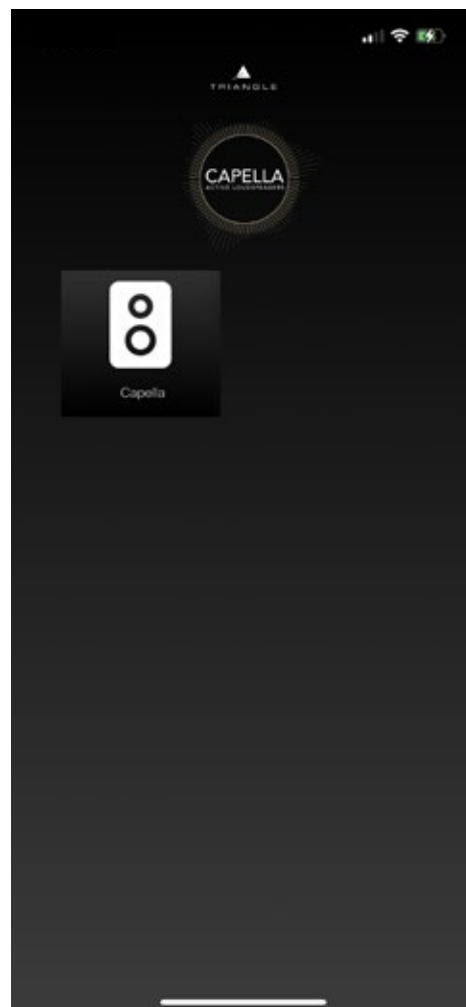

2. Launch your app, then click on the icon corresponding to your system



If your CAPELLA system does not appear on the app, restart your Stereo Hub by disconnecting / reconnecting the power supply and wait for the start-up sequence to complete.

## 9.A DESCRIPTION OF THE HOMEPAGE

The homepage represented by the  icon, is used as a playback page. It also lets you select the source, set the volume and access parameters.

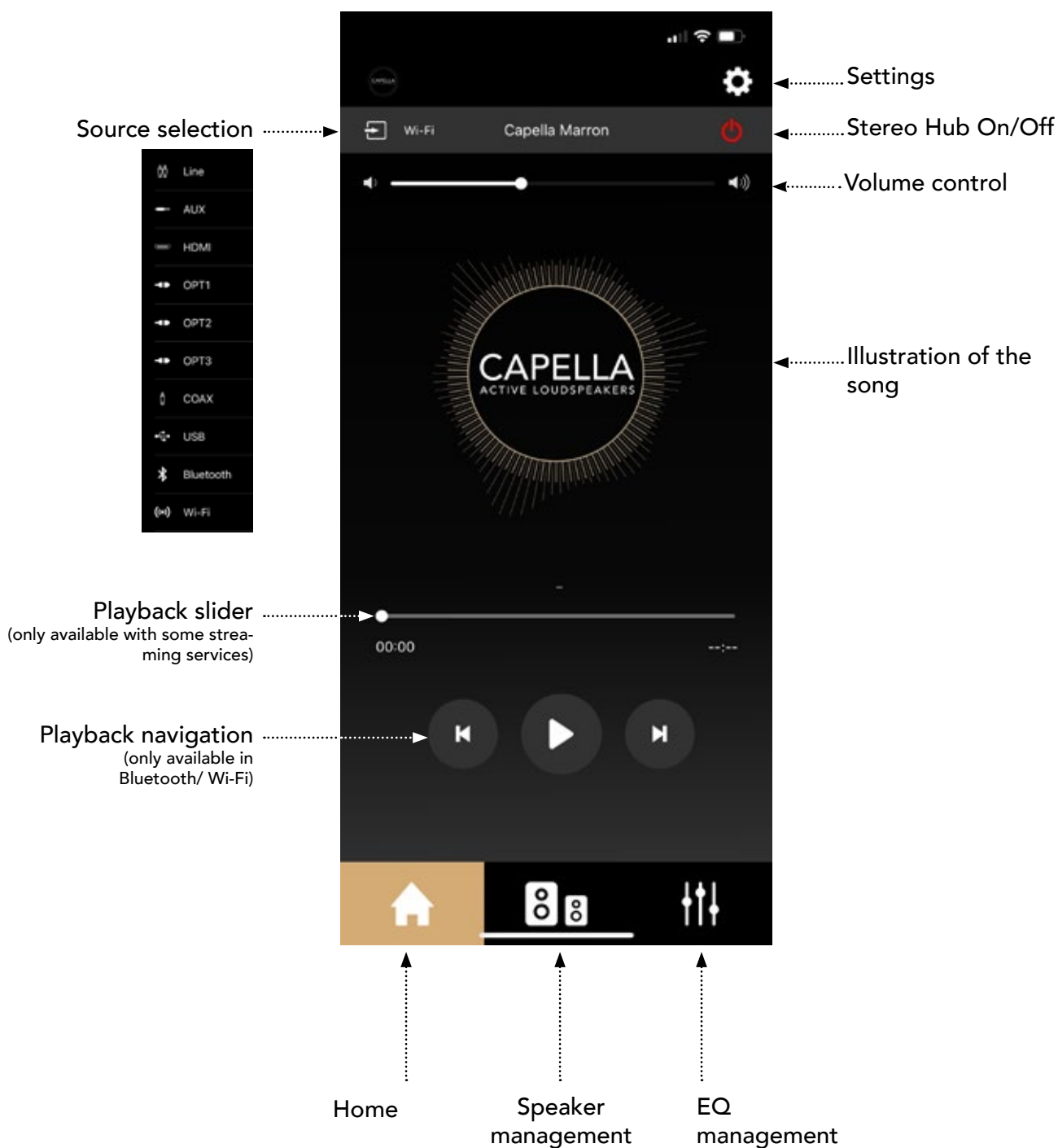

When using Line/Aux/HDMI/Opt/Coax/USB sources, you do not have access to the playback slider or navigation options.

## 9.B SETTINGS

Click the  icon to access the settings:

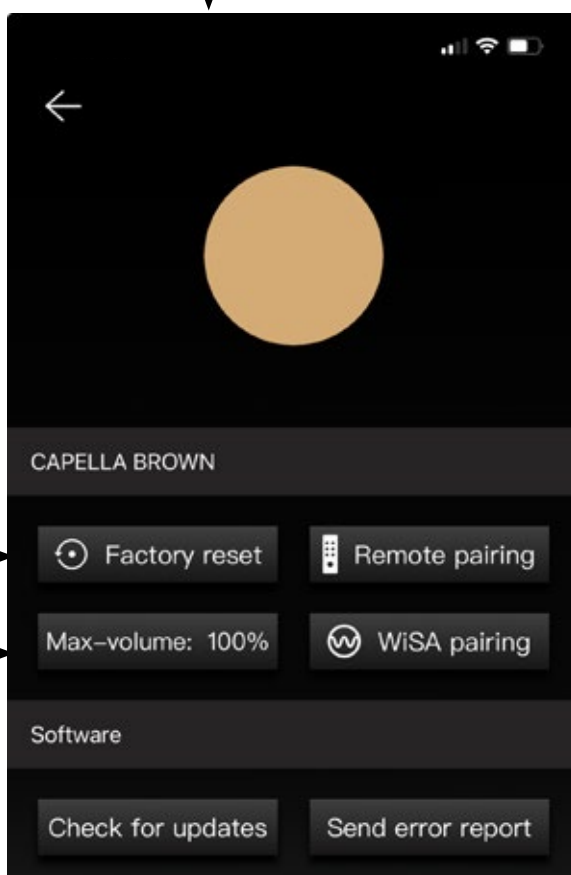

Resetting the Stereo Hub

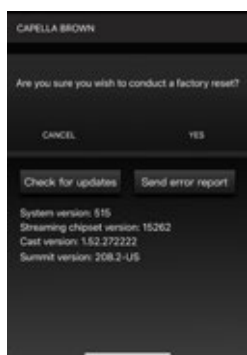

Maximum volume setting



Remote control pairing

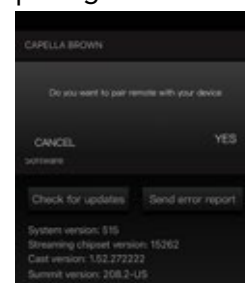

Send a message to report a problem

Update

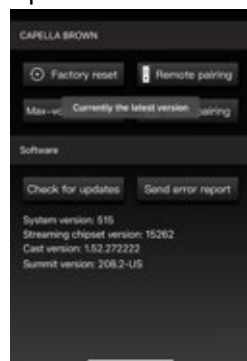

Pairing WiSA devices

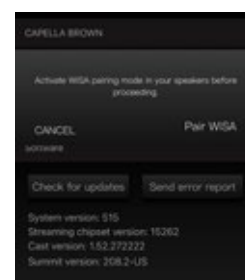

## 9.C SPEAKER SETTINGS

### a. Stereo settings

When you first use your speakers, they are already configured in stereo. Refer to the labels on the back of the speakers to know how to position them. You can move on to the next step.

If you have reset your system to factory settings, both speakers are configured and assigned as "Left speakers". You need to set them to stereo:

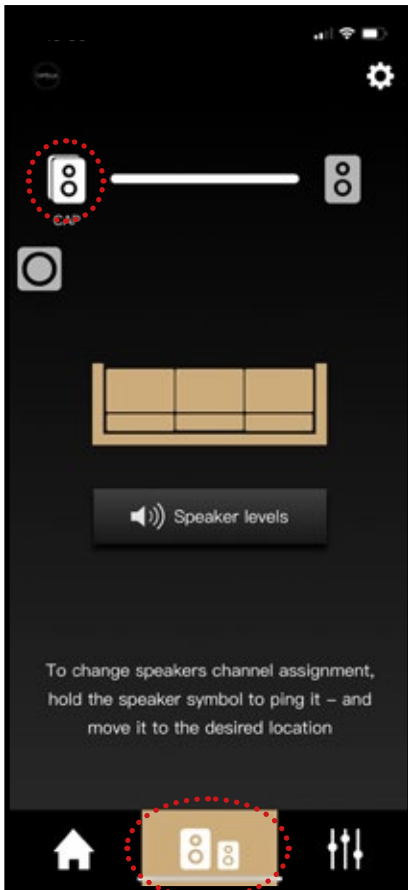

1.

1. Go to the second tab of the app. Two speaker icons are superimposed on the left-hand side.

2. Click on the icon  to make them appear separately.

Hold your finger on one of the speaker icons to ping it. This allows you to easily identify left and right speakers

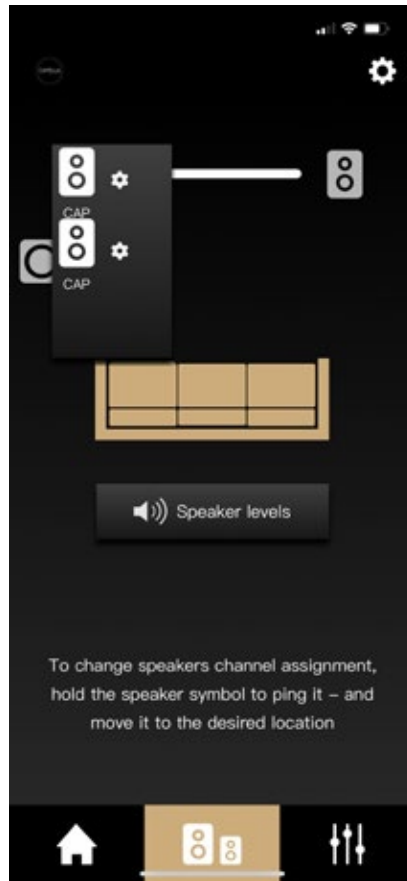

2.

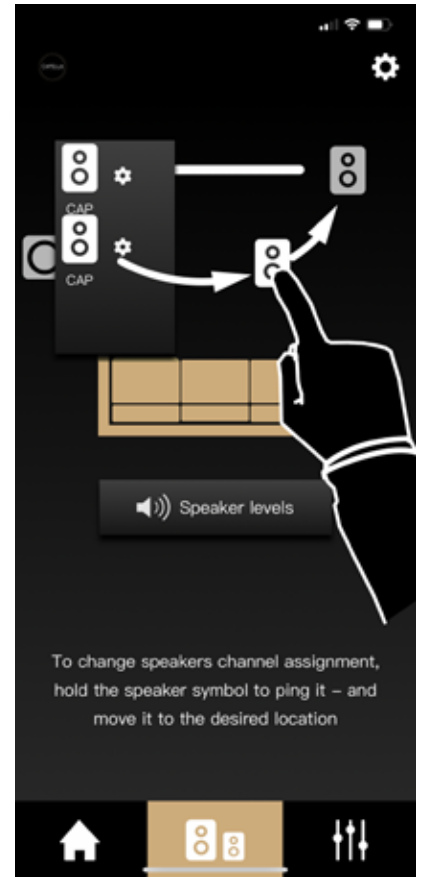

3.

3. Press and hold the icon of the speaker emitting the sound on the right to "drag and drop" it to the desired location on the right.

Perform a final test by pressing each speaker icon successively to emit a sound and check that they are correctly positioned.

Your speakers are now set to stereo.

## 9.C SPEAKER SETTINGS

### b. Setting the mode and distance

Press the left and right speaker icons successively to access the settings.

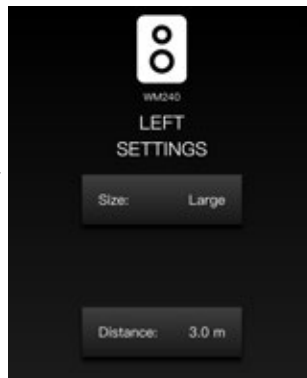
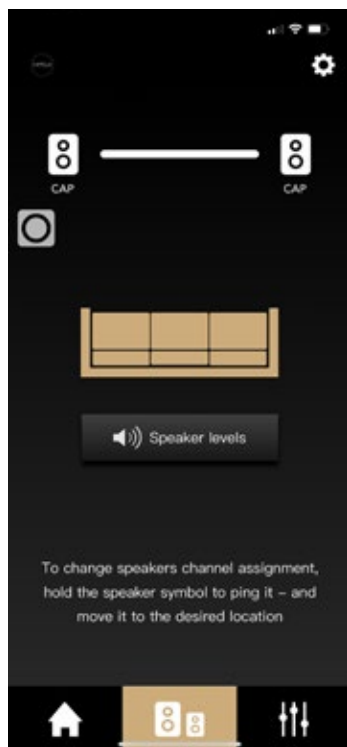

Size Large: This mode is recommended for your CAPELLA system if you do not have a subwoofer.

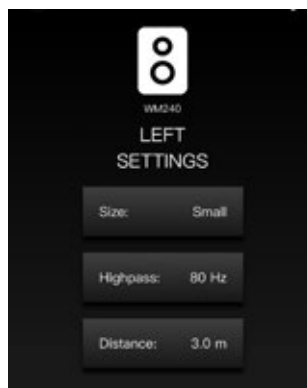

Size Small : Use this mode if you have a subwoofer or wish to limit the low frequencies of your system.

Setting the frequency roll-off of your speakers to match your subwoofer. (filter 24dB/ Oct.)

Setting the distance between the speaker and the listening position

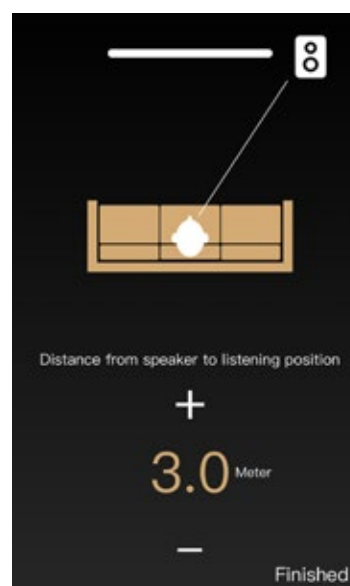



## 9.C SPEAKER SETTINGS

### c. Level adjustments

Press "Speaker levels" to access the adjustments.

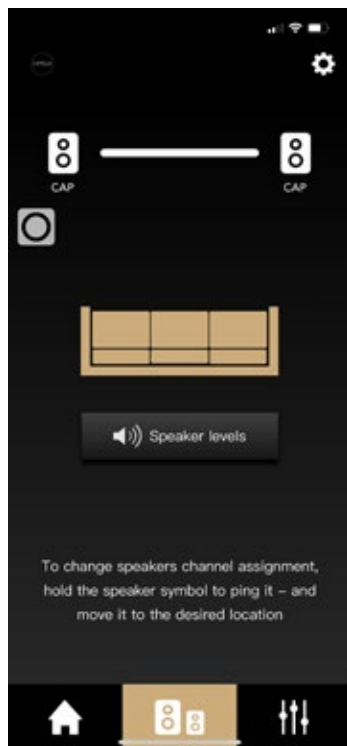

Sound level adjustment of your speakers according to your listening position.

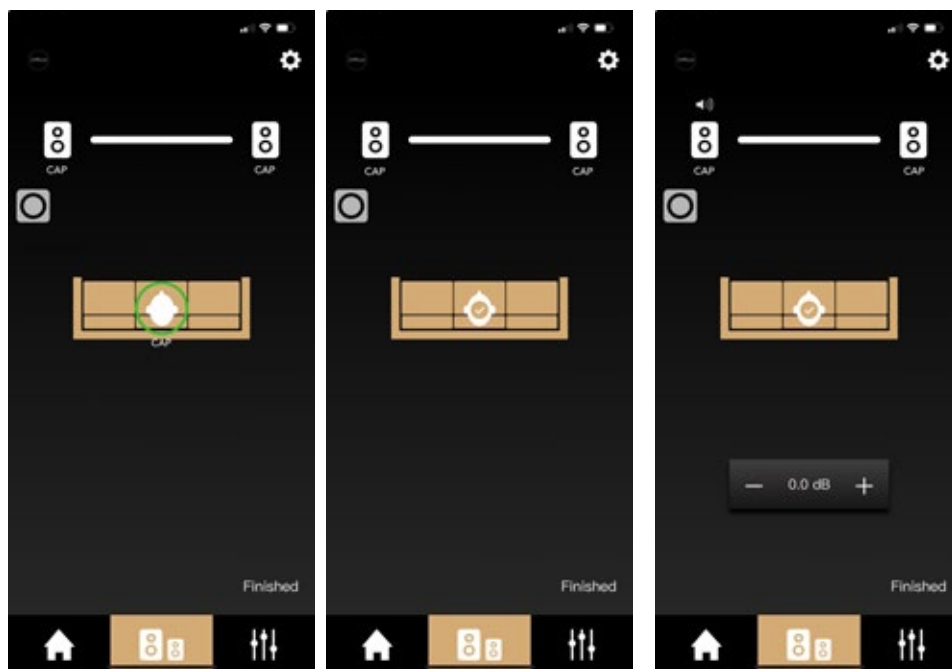

Place yourself on your listening position.

Then validate your position by clicking on the green circle.

Select the left and right speaker icon, then adjust the sound level of each if necessary.

## 9.D INTRODUCTION TO “EQ” FUNCTIONS



The CAPELLA app can be used to perform an acoustic calibration of your system, followed by various sound adjustments. CAPELLA is an intelligent audio system that adapts to your environment, while giving you the freedom to make precise adjustments to match your personal preferences.

The factory settings of your speakers make full use of your system’s potential; they are configured in a wide mode with no limitations. To personalize your listening experience, we recommend the following settings.

Acoustic calibration of the system is carried out in two stages:

- “Room EQ” to compensate for any flaws specific to your room.
- “Manual EQ” for sound adjustment with various filter tools.

Before choosing these settings, here are a few important concepts:

When using “Room EQ” or “Manual EQ”, one element remains unchanged: the frequency response curve:

- The vertical scale represents the sound level expressed in decibels (dB).
- The horizontal scale represents the frequency range expressed in Hertz (Hz).

“Room EQ” makes automatic adjustments over a frequency range of 10Hz to 400Hz.

The original signal sent during “Room EQ” measurement, known as pink noise, sweeps across all frequencies at a constant level, representing a straight line on the response curve. The aim is to ensure that the signal reproduced after passing through the speaker represents this same straight line, so that sound reproduction is consistent with the original signal.

However, we are about to discover that the signal reproduced by the speaker is disturbed by various elements, which have a considerable impact on sound reproduction, independently of your speaker’s original performance. Your CAPELLA system has some powerful patches to address this.

“Manual EQ” acts over the entire audible frequency range, i.e. from 20Hz to 20kHz, 20Hz corresponding to low frequencies and 20kHz to high frequencies. Between the two lie a multitude of nuances and details, including the midrange frequencies associated with vocals. We will explain later on what these frequencies represent, to give you a clear guide when you use “Manual EQ” for your final adjustments.

## 9.E DESCRIPTION ON THE EQ

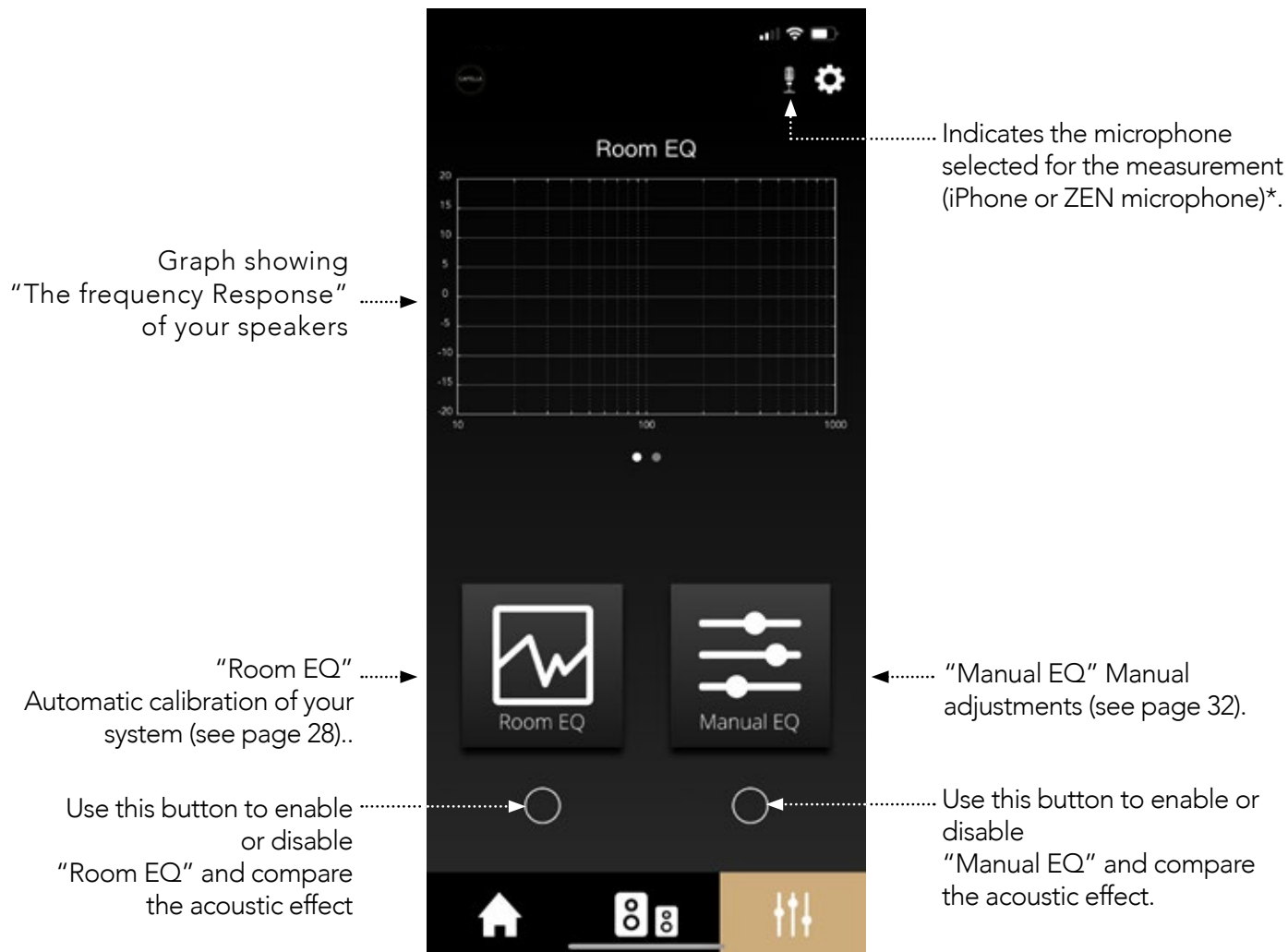

.....

**WARNING** To access "Room EQ" on Android, you will need the external ZEN microphone, available as an option on our website. (See page 40)

.....

## 9.F ROOM EQ

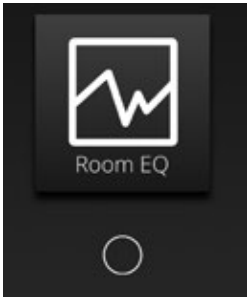

“Room EQ” automatically calibrates your system according to the acoustic limitations of your room. As they propagate, the audible frequencies from 20Hz to 20kHz cause a variety of phenomena with varying degrees of impact on your listening experience.

To explain these phenomena simply, we can characterize them in 4 diffraction zones, each zone being defined by a frequency band: (example for a medium-sized room)

- Zone 1: From 20Hz to 40Hz. (sub-bass)
  - 40Hz is the frequency below which uniform pressure variations are observed, with no resonance “mode”.
  - This means you can move around the room without feeling any noticeable difference in this frequency range.
- Zone 2: From 40Hz to 250/300Hz. (low frequency)
  - 250/300Hz corresponds to the Schroeder frequency, which separates the resonating and reverberating behavior of a room.
  - This zone is the one that causes the most listening disturbance, with room modes and standing waves. Depending on your position in the room, the level of these frequencies can vary considerably.
- Zone 3: From 250/300Hz to 5000Hz. (mid-high frequency)
  - This zone has a high number of resonances and complex modes that can only be treated statistically.
  - Even so, the sound is easily diffracted by the physical elements in your room. A greater number of diffracting elements means your room will be more acoustically neutral.
- Zone 4: Above 5000Hz (high frequency)
  - This zone concerns only high frequencies (treble), which propagate like light in the presence of obstacles.
  - Those frequencies are absorbed by soft surfaces and reflected by smooth, hard ones. The strong directivity of these frequencies is more of a problem than the room itself. In other words, we recommend that you face your speakers to benefit from all the frequencies at the top of the sound spectrum.

“Room EQ” handles the most problematic zone, i.e. zone 2 with the low frequencies. The acoustic pressure of these frequencies reflects against the walls of your room, creating various resonance-like phenomena known as “room modes”. These modes operate in all three dimensions and affect your listening experience according to where you are in the room, reproducing some frequencies at different levels. “Room EQ” adapts the low-frequency response to your room, making the Capella speakers stand out from traditional loudspeakers, for which this type of processing is impossible.

To complete this step, you need a microphone. If you own an iPhone of a higher generation than the iPhone 6S, this operation is possible from your smartphone. For Android\* smartphone users or for more precise measurements, you will need to purchase the ZEN microphone, available on our website or from your local dealer (p.69).

## 9.F ROOM EQ

To learn how to use and configure the ZEN microphone, please refer to the appendix 2 page 69 before starting your measurements.

At the start of the test, your speakers will emit a pink noise; you will then need to move around your room with your microphone, following a few simple rules. Taking measurements in different places allows us to cover your entire room and correct most problems.

All the data is sent and processed by your smartphone using powerful mathematical and analysis tools, in just a few seconds. The calculated data is then sent to the Stereo Hub, which sends it back to the Capella speaker.

### Practice

- Ensure your CAPELLA system is switched on.
- Then check that you have configured the ZEN microphone correctly (page 69) and that the battery is sufficiently charged.
- Turn on the microphone by simply pressing the action button; the LED quickly turns green. (No action is required if you use your iPhone's built-in microphone.)
- Then follow these steps from your app :

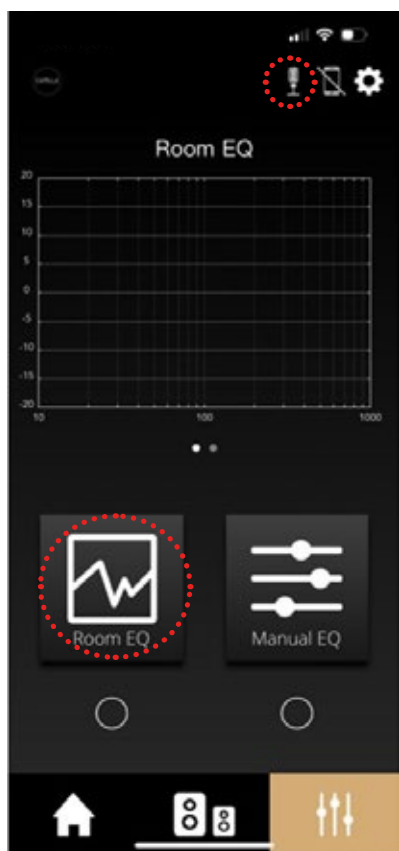

Click on "Room EQ".

\*Zen microphone available

## 9.F ROOM EQ

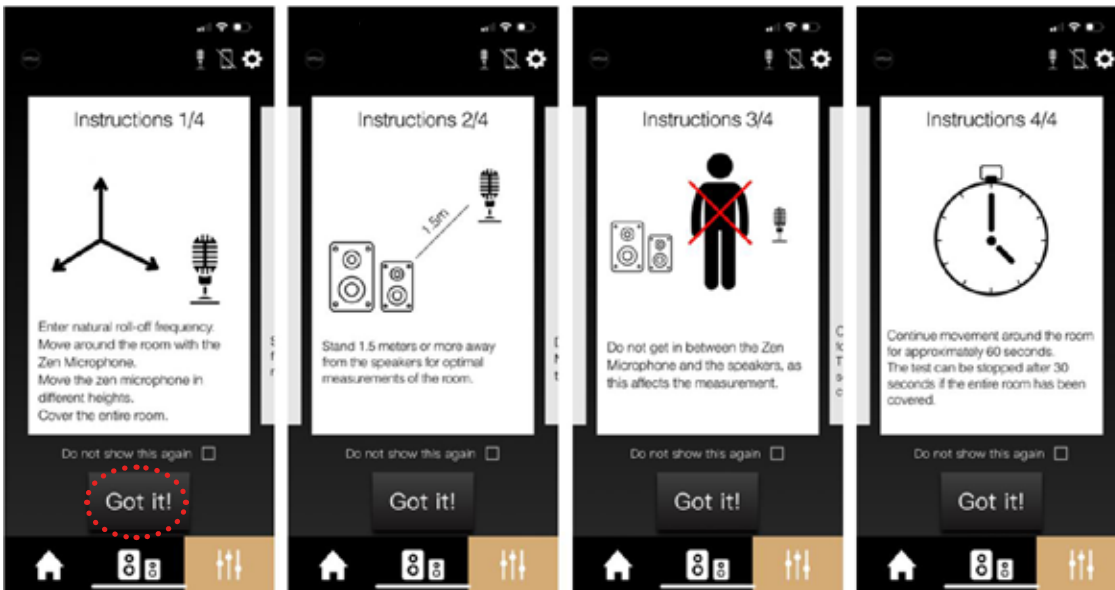

When taking measurements, follow the recommendations below:

- ▶ Move around the room with the microphone to cover the entire room, positioning it at different heights.
- ▶ Keep within 1.5m of your speakers. Make circular movements with your arm.
- ▶ Do not get in between the speakers and the microphone.
- ▶ Take measurements for 60 seconds. The test can be stopped earlier if you have covered the entire room.

Click on "Got it!".

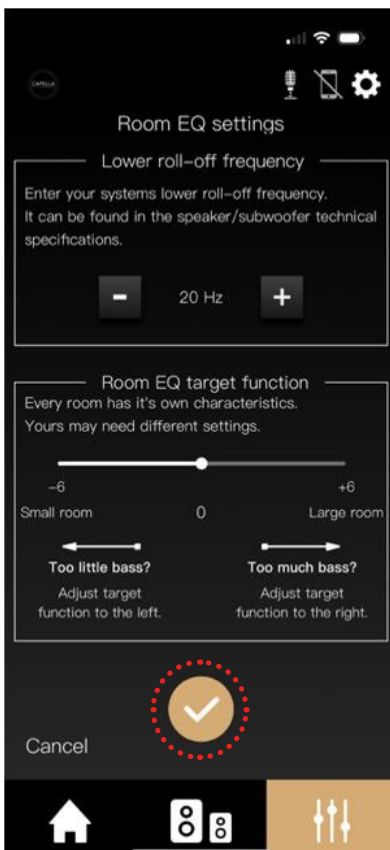

« Lower roll-off frequency”: System stop frequency (low frequency at -6dB). For your CAPELLA system, we recommend setting it to 35Hz, as the analysis will focus only on frequencies that can be reproduced by your system.

“Room EQ target function”: Each room has its own characteristics, so you can extend the low-frequency response. If you do not experience too much resonance, you can move the slider to the right. On the other hand, if you do experience resonance and your room does not “absorb” it, then move the slider to the left;

Then click on 

## 9.F ROOM EQ

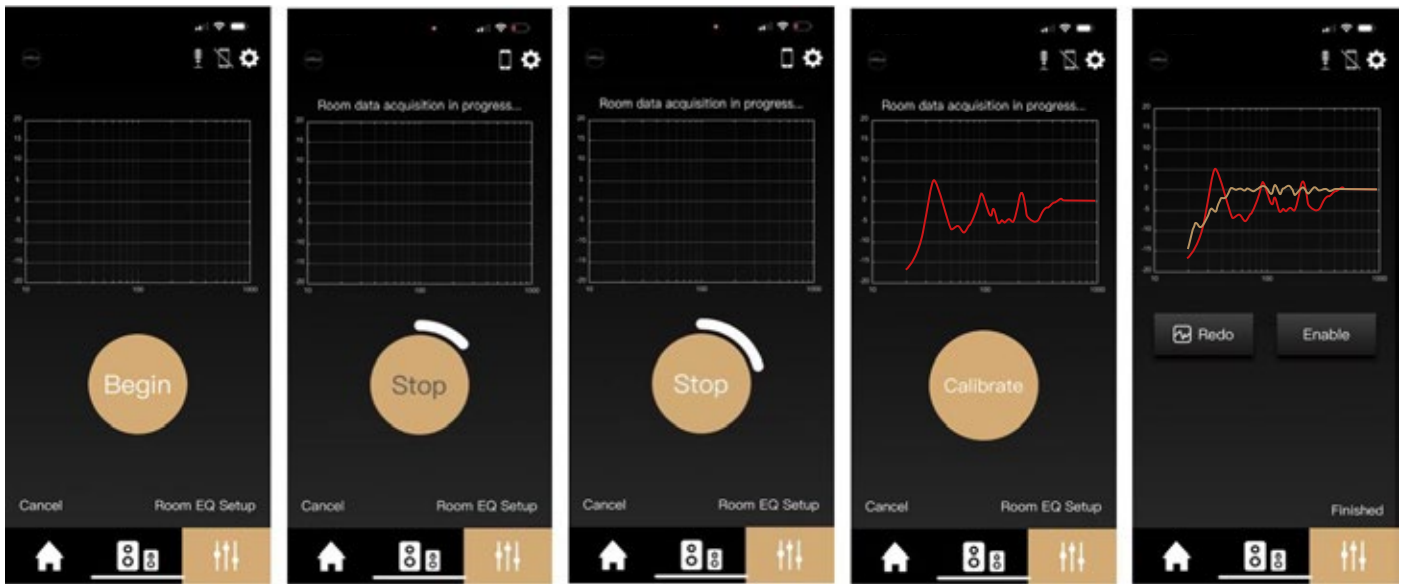

- ▶ With your microphone, start taking measurements in different parts of the room, as described above.
- ▶ Then click on "Begin", the LED on your ZEN microphone turns red. The speakers start producing a constant pink noise, and you have 60 seconds to take as many measurements as possible.
- ▶ If you think you have covered the entire room, you can stop the operation as soon as the "Stop" indicator turns white.
- ▶ Once the operation is complete, a red frequency response from the speakers in your room appears. These disturbances on the curve, which is supposed to be linear, are mainly linked to your room. We are going to correct them.
- ▶ Click on "Calibrate". In yellow, you see the frequency response corrected by the Room EQ. The difference between the two curves can be striking.
- ▶ Click on "Finished" to finalize the measurements with the Room EQ.
- ▶ By clicking on the small white circle below the Room EQ icon, you can enable or disable this setting when listening. You will notice a significant improvement of your listening experience.

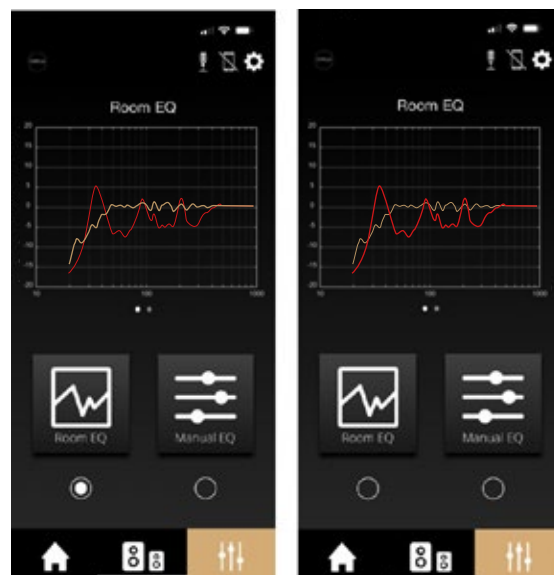

## 9.G MANUAL EQ

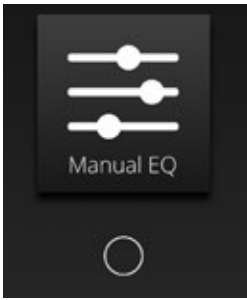

The “Manual EQ” function lets you fine-tune your speakers.

The various settings available have a direct effect on your CAPELLA system’s response curve. You can adjust these settings while listening to a song, and see the correction made by enabling or disabling the function.

To ensure optimum use, it is best to have a basic understanding of the frequencies used and their functions. As previously mentioned, the human ear perceives frequencies between 20Hz and 20,000Hz. Low frequencies are at the beginning (bass), high frequencies at the end (treble). In between, you find a multitude of nuances and details.

To help you adjust your Manual EQ settings correctly, here are a few guidelines. Consider that the audible frequency band can be divided into eight frequency zones as follows:

- ▶ Infrasonic frequencies (1Hz-20Hz): reproduced, for example, by earthquakes or large organs. This is more the sensation of a vibration than an audible sound.
- ▶ Very low frequencies (20Hz-40Hz): reproduced, for example, by the bass drum of a drum kit, or the low notes of a piano or bass guitar. You need large speakers or a subwoofer to reproduce these frequencies.
- ▶ Low frequencies (40Hz-160Hz): these are the bass foundations of the music, providing roundness and impact. Setting this zone is an important part of the “Manual EQ”.
- ▶ Mid-low frequencies (160Hz-315Hz): reproduced by the piano’s middle C note.
- ▶ Average frequencies (315Hz-2.5kHz): reproduced, for example, by the speaker of your mobile phone.
- ▶ Mid-high frequencies (2.5kHz -5kHz): this zone is sensitive for our hearing, as the frequencies emitted are close to the ear’s resonance frequency.
- ▶ High frequencies (5kHz-10kHz): these are harmonics of the notes produced in the previous zones. These frequencies are highly directive, and often require you to stand in front of the speakers to fully perceive them.
- ▶ Very high frequencies (10kHz-20kHz): these are also harmonics of the highest notes, specific to some instruments. This range is more difficult to perceive, as the sensitivity of the ear deteriorates over time.



## 9.G MANUAL EQ

Musical instruments navigate these different ranges. Here is a diagram showing the respective frequency ranges:

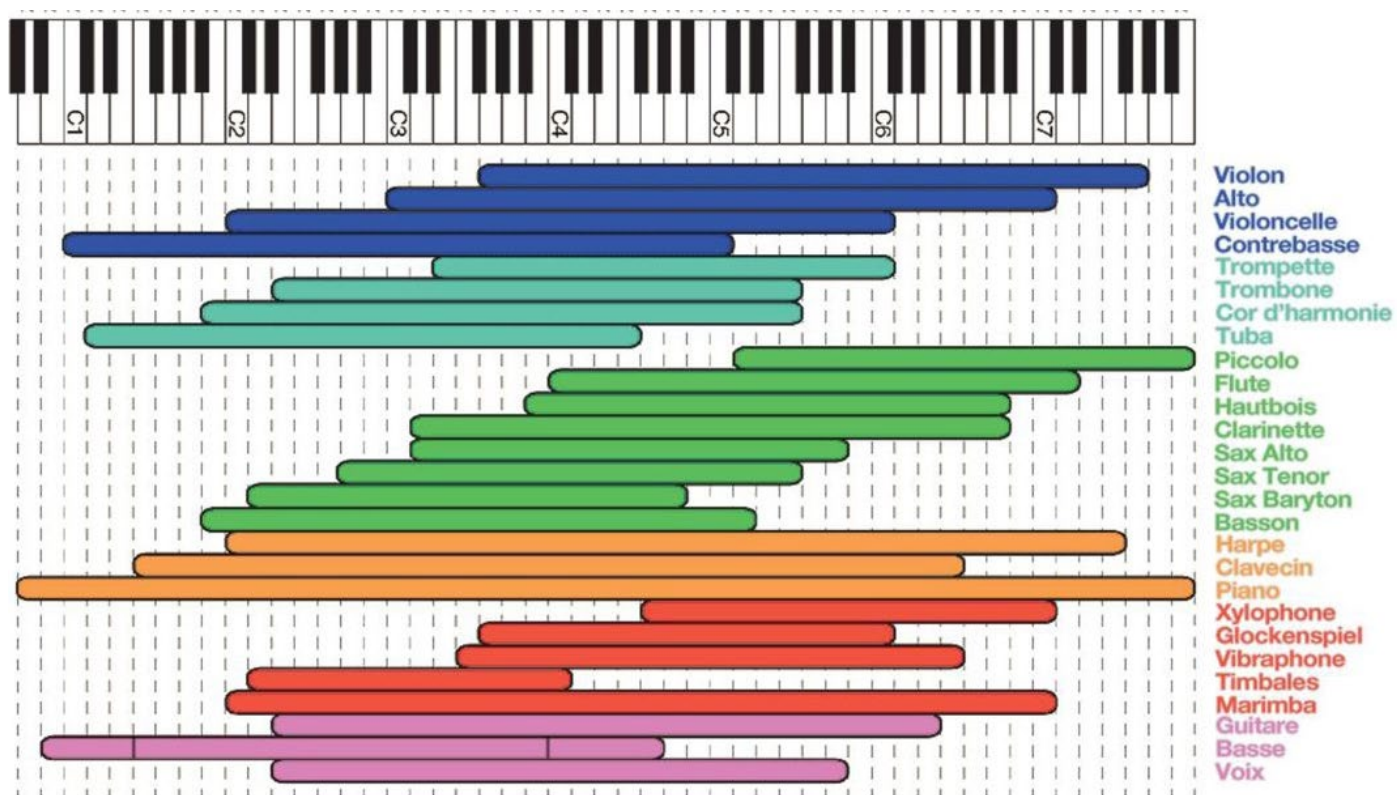

## 9.G MANUAL EQ (SUITE)

### Practice

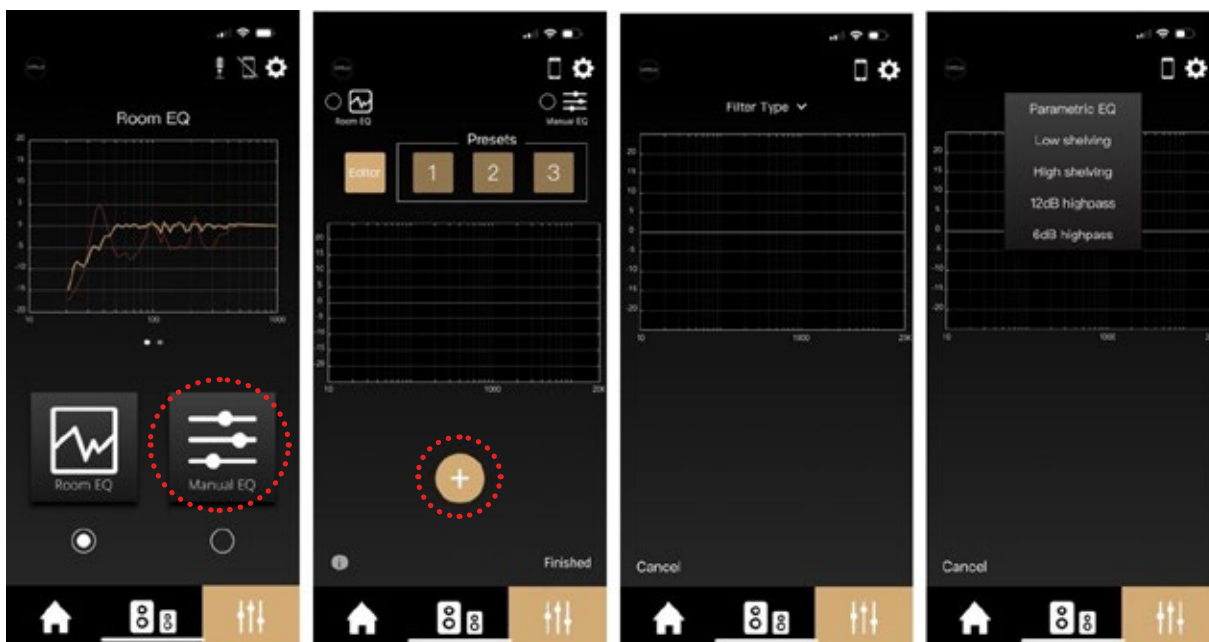

- Click on the “Manual EQ” icon.
- Then click on “+”. A curve appears with a drop-down menu showing different types of filters. Let’s look at each of these settings one by one, then explain their functions.

Parametric EQ:



“Parametric EQ” allows you to fine-tune the frequency you feel you need to improve as you listen. For example, a frequency recognized as sensitive, around the ear’s resonance frequency, or a resonance to be attenuated on an instrument, a voice, etc. This setting accentuates or attenuates the restored level of this frequency.

## 9.G MANUAL EQ

- Click on "Parametric EQ". A yellow line appears on the graph: this is the theoretical frequency response of your speaker when a pink noise passes through it.
- Click on "F" for frequency, to adjust between 10Hz and 20kHz. In our example, we will set it to 2800Hz (the ear's resonant frequency range), then confirm with "✔".



- Then click on "Gain", to adjust between -10dB / +10dB. It determines the decibel level of the correction to be applied to the selected frequency. In this example, we will set it to +2. Confirm with "✔". You can now see how your settings affect the curve.

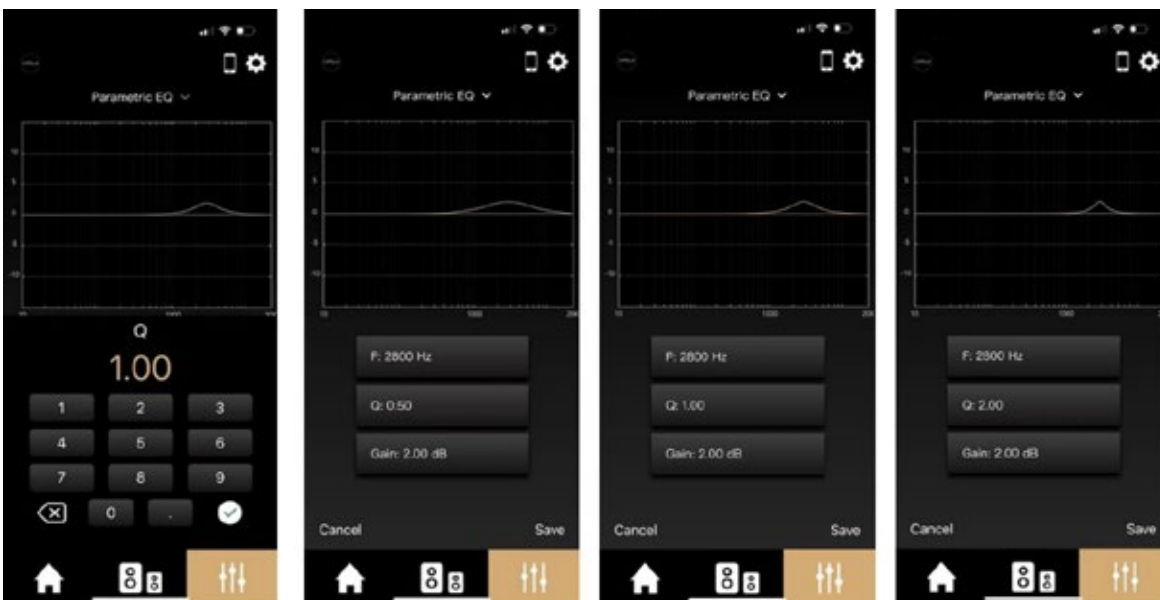

- Now click on the "Q" coefficient, to adjust from 0.01 to 30. The Q determines the frequency bandwidth; the lower the value, the wider the band. Let's take 3 different values as an example, 0.5/1/2.
- Click on "Save" to save your settings and proceed to a listening test by enabling or disabling this new filter.

## 9.G MANUAL EQ

### Low shelving :

“Low shelving” allows you to increase or decrease the low end of the frequency spectrum. The low register will be directly affected. This setting adjusts the overall level of low frequencies.



- Click “Low shelving”.
- Then click on the frequency and set the end of this filter. For example, we want less low frequencies, so we are going to work on a range from 10Hz to 120Hz and enter the 120Hz frequency. Let’s take two examples of gain adjustment: -2dB of sound level on the 10Hz to 120Hz band, or +2dB on the same band. This attenuates or boosts the bass level.
- Save the 2dB attenuation and listen again, switching this new filter on or off.

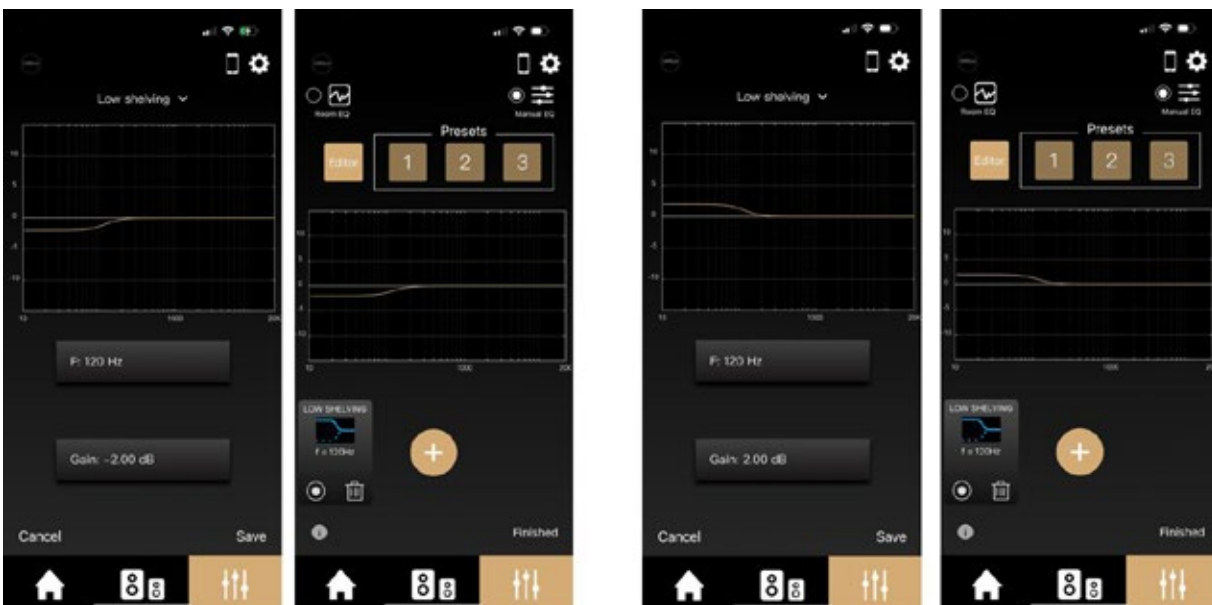

- Save your setting in your “Presets” by pressing and holding the number 1/2/3 if you are satisfied with your setting.

## 9.G MANUAL EQ

### High shelving :

“High shelving” allows you to increase or decrease the high end of the frequency spectrum. The high frequency register will be directly affected. This setting adjusts the overall level of high frequencies.



- ▶ Click “High shelving”.
- ▶ Then click on the frequency and set the start of this filter. For example, we want less high frequencies, so we are going to work on a range from 6kHz to 20kHz and enter the 6kHz frequency. Let’s take two examples of gain adjustment: -2dB of sound level on the 6kHz to 20kHz band, or +2dB on the same band. This attenuates or boosts the high frequency level. Save the 2dB attenuation and listen again, switching this new filter on or off.



- ▶ Save your setting in your “Presets” by pressing and holding the number 1/2/3 if you are satisfied with your setting.

## 9.G MANUAL EQ

### 12dB highpass :

The “12dB highpass” defines a highpass filter with a raw slope at 12dB/Oct. This means setting the frequency at which your speakers will start to operate in the low frequencies, with very little drag on frequencies below the set frequency. This setting is very useful for adapting your speakers to the dimensions of your room.

The CAPELLA speakers, which feature a DSP with permanent control over the drivers, are highly capable of reproducing low frequencies. They perform best when adjusted to their environment. We recommend applying a 45Hz filter and then gradually increasing it in 5Hz steps to find the cut-off that best suits your listening room. The low frequencies should be firm and tight, without excessive drag.

With this function, you can also set a filter around 90/120Hz if your speakers are coupled with a subwoofer.



- ▶ Click on “12dB highpass”.
- ▶ Then click on the frequency and set the start of this filter. For example, we have a medium-sized room, so we’ll apply a 60Hz filter. This filter prevents the reproduction of all lower frequencies, which are difficult to reproduce due to the numerous resonances linked to the dimensions of our room.
- ▶ Then adjust the “Q” coefficient: the higher the value, the higher the sound level of the cut-off frequencies.
- ▶ To illustrate the influence of this setting, let’s consider a “Q” of 0.7/0.8/1.2.
- ▶ Save the setting and listen again, switching this new filter on or off.

## 9.G MANUAL EQ

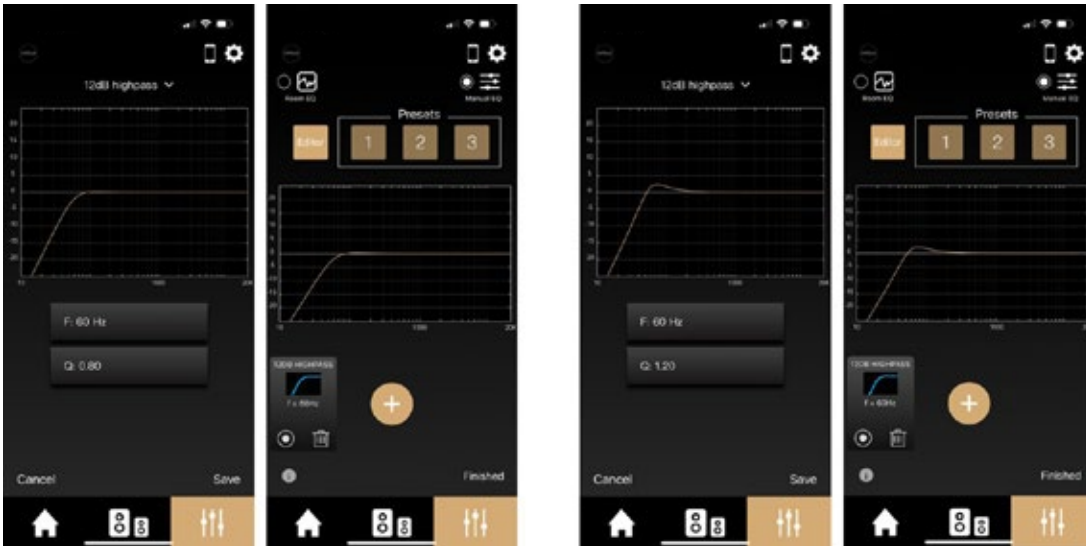

- Save your setting in your “Presets” by pressing and holding the number 1/2/3 if you are satisfied with your setting

### 6dB highpass :

The “6dB highpass” defines a highpass filter with a gentle slope at 6dB/Oct. This means setting the frequency at which your speaker will start to operate in the low frequencies, with a softer cut-off on frequencies below the set frequency than a 12dB/Oct filter. This setting is very useful for adapting your speakers to the dimensions of your room.

The CAPELLA speakers, especially thanks to their advanced DSP programming, have a high capacity for low-frequency restitution. They perform best when adjusted to their environment. We recommend applying a 50Hz filter and then gradually increasing it in 5Hz steps to find the cut-off that best suits your listening room. The low frequencies should be firm and tight, without excessive drag.

You can also set a filter around 90/120Hz if your speakers are coupled with a subwoofer.

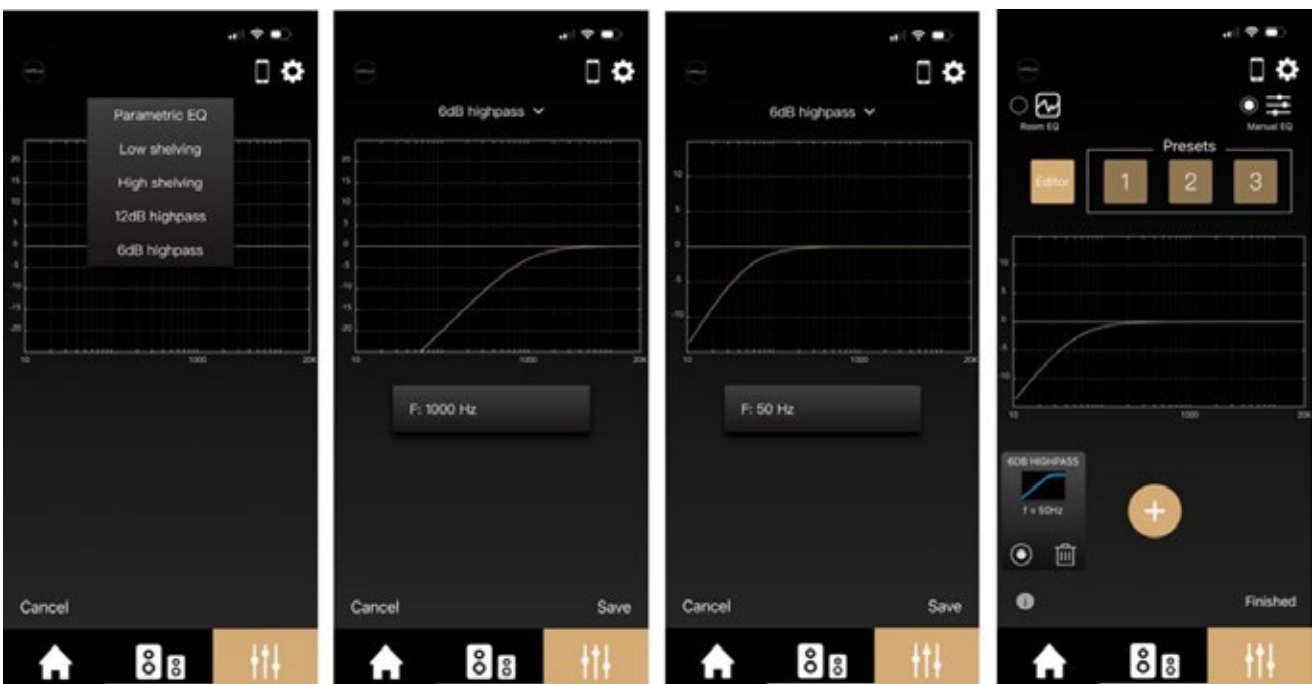

## 9.G MANUAL EQ (SUITE)

- Click on “6dB highpass”.
- Then click on the frequency and set the start of this filter. For example, we have a medium-sized room, so we will apply a 50Hz filter. This filter prevents all lower frequencies, which are difficult to reproduce due to the numerous resonances linked to the dimensions of our room.
- Save the setting and listen again, switching this new filter on or off.
- Save your setting in your “Presets” by pressing and holding the number 1/2/3 if you are satisfied with your setting.

### Multi EQ :

For optimal setting, a combination of filters is required. We invite you to test these different settings for your CAPELLA speakers:

- ▶ A “12dB highpass” set between 45 and 80Hz with a steep slope to adapt the low frequencies to the capacity of your listening room.
- ▶ A “6dB highpass” set between 40 and 80Hz with a gentle slope to adapt the low frequencies to the capacity of your listening room.  
(Since both settings perform the same function, they should be activated successively)
- ▶ A “Parametric EQ” with an increase in the 400Hz frequency level due to a perceived lack of level on some instruments.
- ▶ A “Parametric EQ” with an attenuation in the 2800Hz frequency level sensitive to the ear.
- ▶ A “high shelving” from 6kHz to boost high frequencies that are difficult to hear.

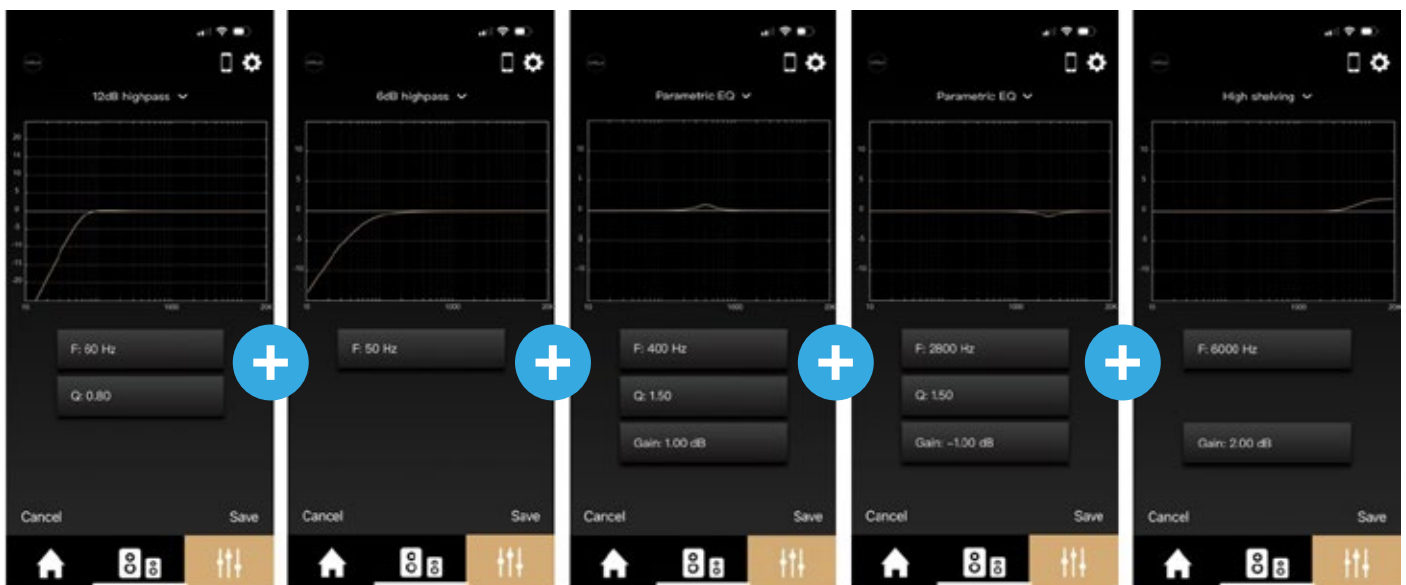

Simply press “+” to add the various settings.

If only the “12dB highpass” is activated, the final curve will be as follows:

:



## 9.G MANUAL EQ

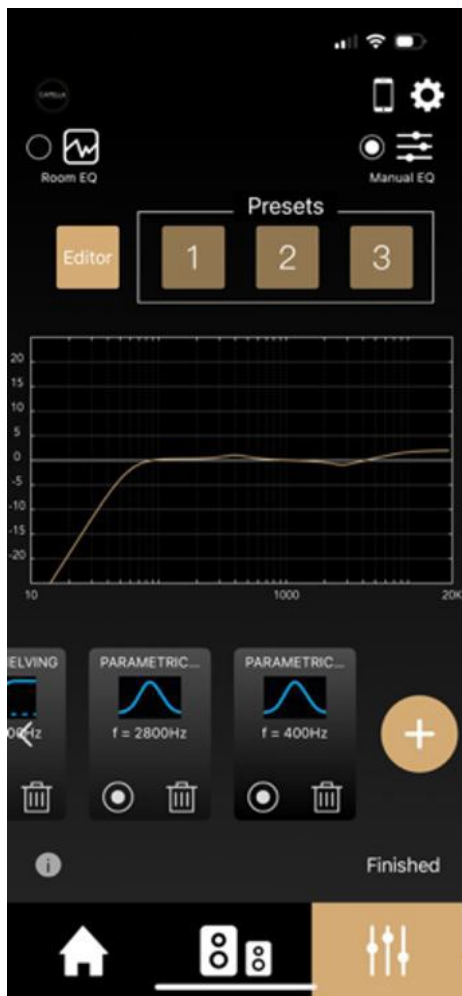

Perform a listening session, then activate/deactivate each of these filters individually to assess their effectiveness.

We recommend that you save this setting by pressing and holding one of the "Presets".

If you wish to change this setting, press and hold the selected "Preset" again, then copy this setting to the "Editor." You will then be able to retrieve all the functions of your various filters or add new ones.

You can also combine Room EQ and Manual EQ settings, so you can easily add extra settings after your Room EQ calibration, especially in high frequencies where no correction is made.

## 10. CONNECTING SOURCES TO THE STEREO

### Connecting with Wi-Fi

Depending on the brand of your smartphone or tablet, the connection protocol differs.

If you have an iPhone/ iPad from Apple, Airplay or Google Cast connections are available. If you have an Android, only Google Cast connection will be possible.

The Spotify Connect and Roon Ready streaming services have their own connection instructions, separate from Airplay or Google Cast.

#### Things to remember when connecting via Airplay:

- ▶ Once your speakers are connected to your streaming service, the Stereo Hub automatically switches to the Wi-Fi source.
- ▶ If you close the streaming service app, the music will stop.
- ▶ If you select another source on your Stereo Hub while listening to a streaming service, the music will automatically pause. When you click Play in the streaming service, the Stereo Hub automatically switches to the Wi-Fi source.

#### Things to remember when connecting via Google Cast:

- ▶ Once your speakers are connected to your streaming service, the Stereo Hub automatically switches to the Wi-Fi source.
- ▶ If you close the streaming service app, the music continues. You need to open the service app again to stop it. (Or you should use the CAPELLA app...)
- ▶ If you select another source on your Stereo Hub while listening to a streaming service, the music will automatically pause, and your speakers are disconnected. You will need to reconnect the speakers to your streaming service to restart the music.

#### Things to remember when connecting to the Spotify Connect / Roon Ready streaming service:

- ▶ Once your speakers are connected to your streaming service, the Stereo Hub automatically switches to the Wi-Fi source.
- ▶ If you close the streaming service app, the music continues. You need to open the service app again to stop it. (Or you should use the CAPELLA app...)
- ▶ If you select another source on your Stereo Hub while listening to these streaming services, the music will automatically pause. When you click Play in the streaming service, the Stereo Hub automatically switches to the Wi-Fi source.

With the Stereo Hub's remote control, you can change tracks forward and backward, as well as pause and play.

## 10.A1 SPOTIFY CONNECT

The Spotify streaming service offers its own solution\*, independent of Google Cast or Airplay, called Spotify Connect. The connection method is similar for IOS & ANDROID.

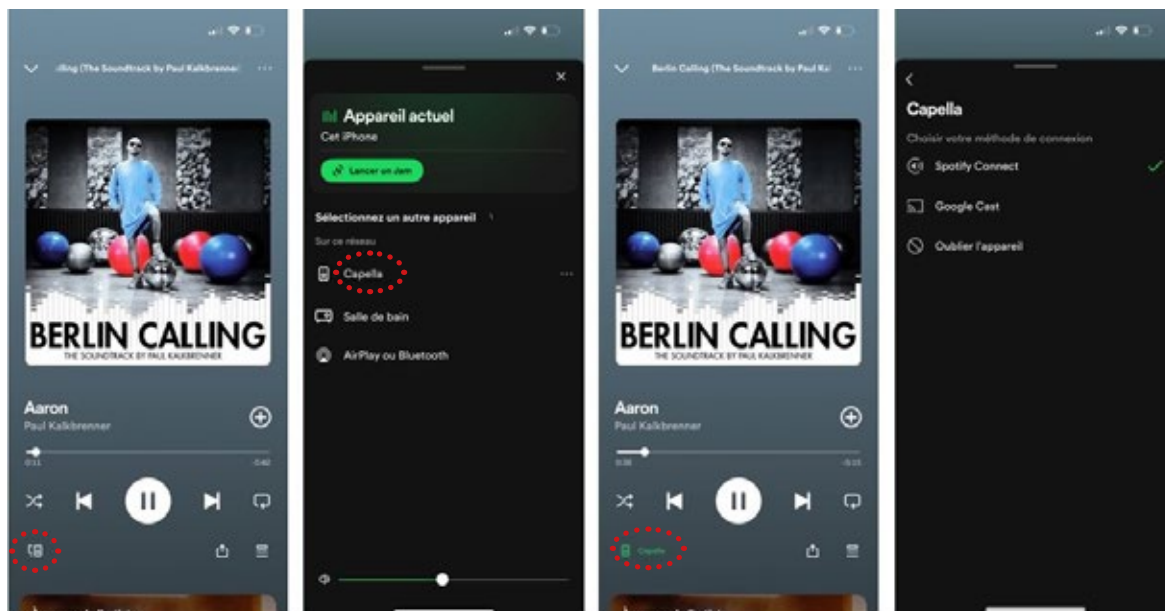

\* You can still connect via Google Cast or Airplay, but the quality will be inferior.

### APPLE

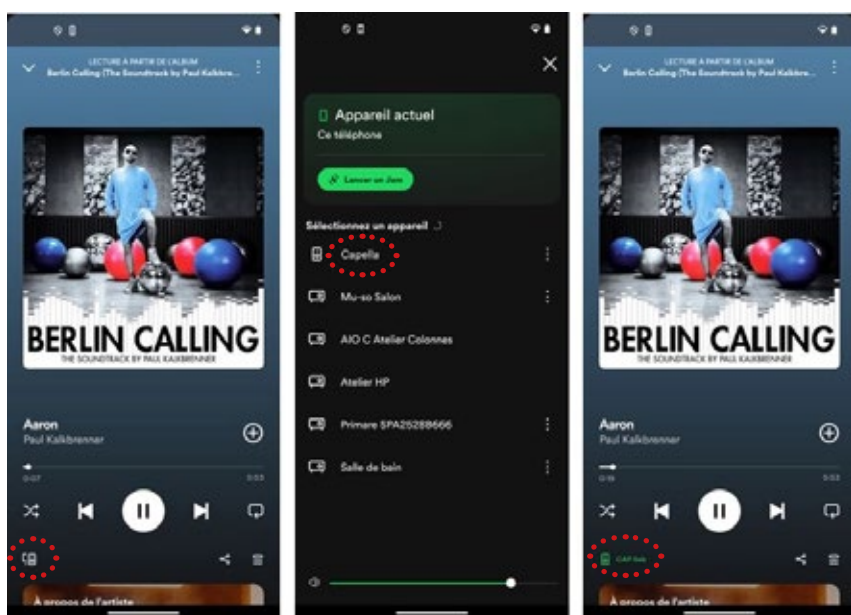

### ANDROID



1. Launch your Spotify app from your smartphone or tablet.
2. Then click on the "  " icon located on the lower left.
3. Select your CAPELLA system from the list.
4. The icon "  " on the lower left turns green (followed by your system name), indicating that your system is connected.
5. You can now start playing your track.

The Wi-Fi LED on your Stereo Hub turns green when listening to Spotify Connect.

If you select another source, the track is paused. Simply press Play in your Spotify app to restart the music, the Stereo Hub will automatically switch to this source.

## 10.A2 ROON READY

Roon offers a complete solution for managing your music stored on your local network or computer. It offers the added advantage of being able to reference all your music and streaming services in a single library, and to obtain a host of information about your tracks and artists. Roon has its own high-resolution connection process, just like Spotify Connect.

\* It is best to first install the Roon app on your computer if you want to access your stored music, then install it on your smartphone or tablet.

Install the "Roon" app on your computer, then follow the instructions :

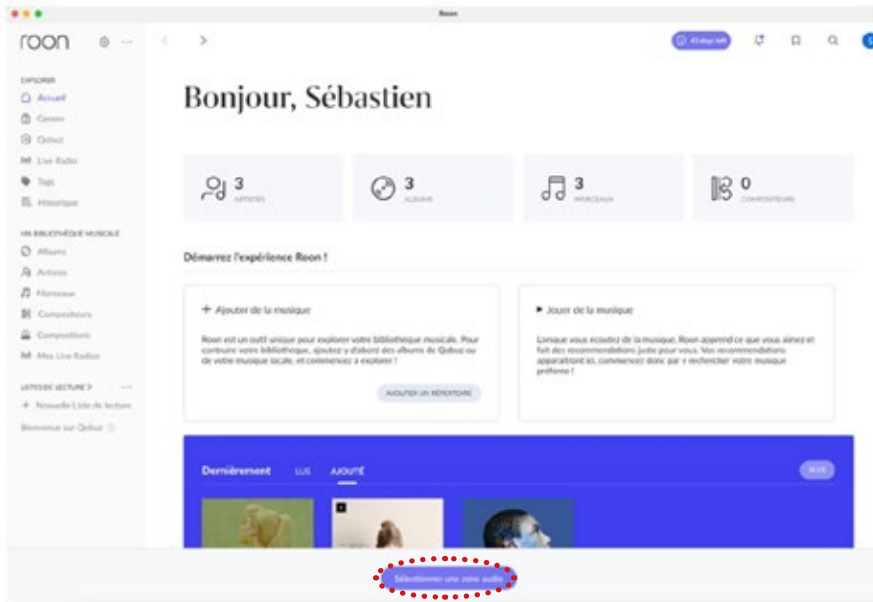

- Click on "Select an Audio Zone".

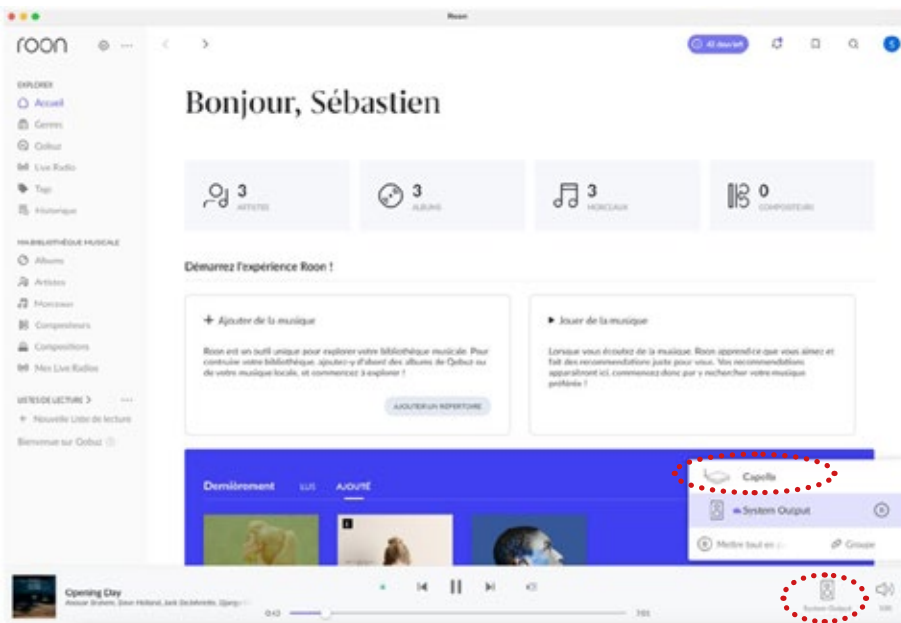

- Then click on "System Output".
- Select the "Capella" system.
- The icon on the lower right indicates that your system is connected.
- You can now start playing your track.

## 10.A2 ROON READY

Follow the instructions below to use Roon on your smartphone or tablet:

### APPLE

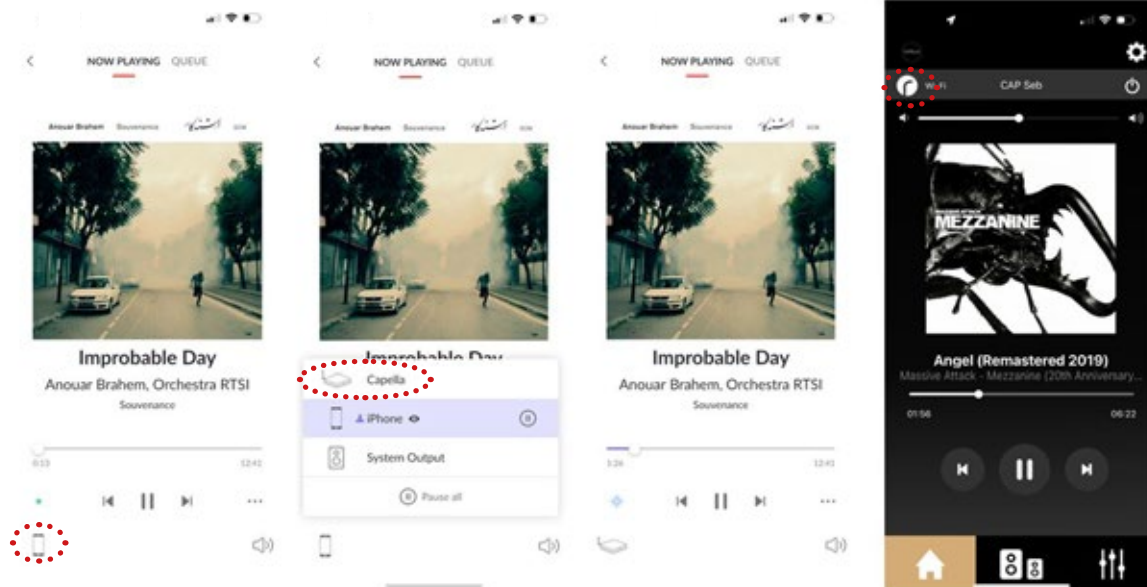

### ANDROID

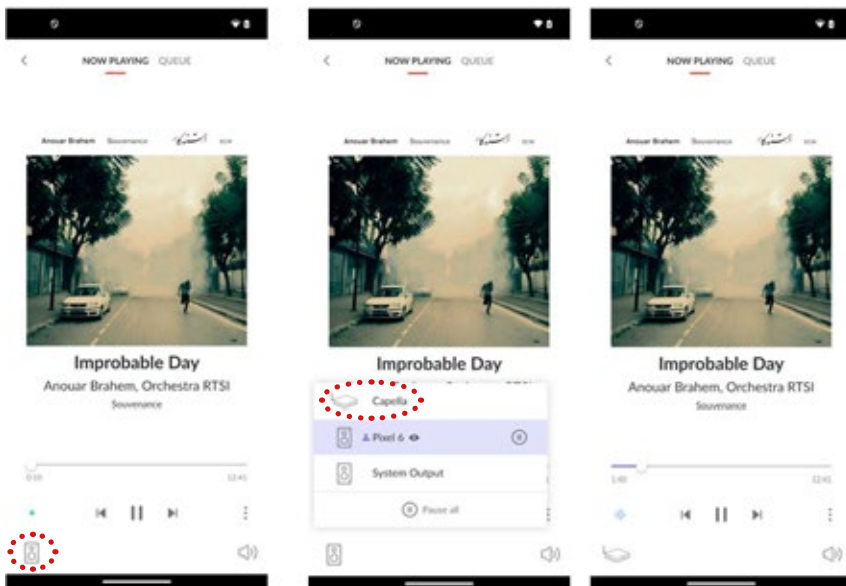

1. Install the ROON app on your smartphone/tablet.
2. Start your Roon app.
3. Then click on the " " icon located on the lower left.
4. Select your CAPELLA system from the list.
5. The icon on the lower left indicates that your system is connected.
6. You can now start playing your track.

If you select another source, the track is paused. Simply press Play in your Roon app to restart the music, the Stereo Hub will automatically switch to this source.

Note: the music continues if you leave the Roon app, you can stop it from the CAPELLA app or by reopening your Roon app.

## 10.A3 DEEZER

The Deezer streaming service offers an Airplay or Google Cast connection on Apple. On Android, only the Google Cast connection is available.

### APPLE

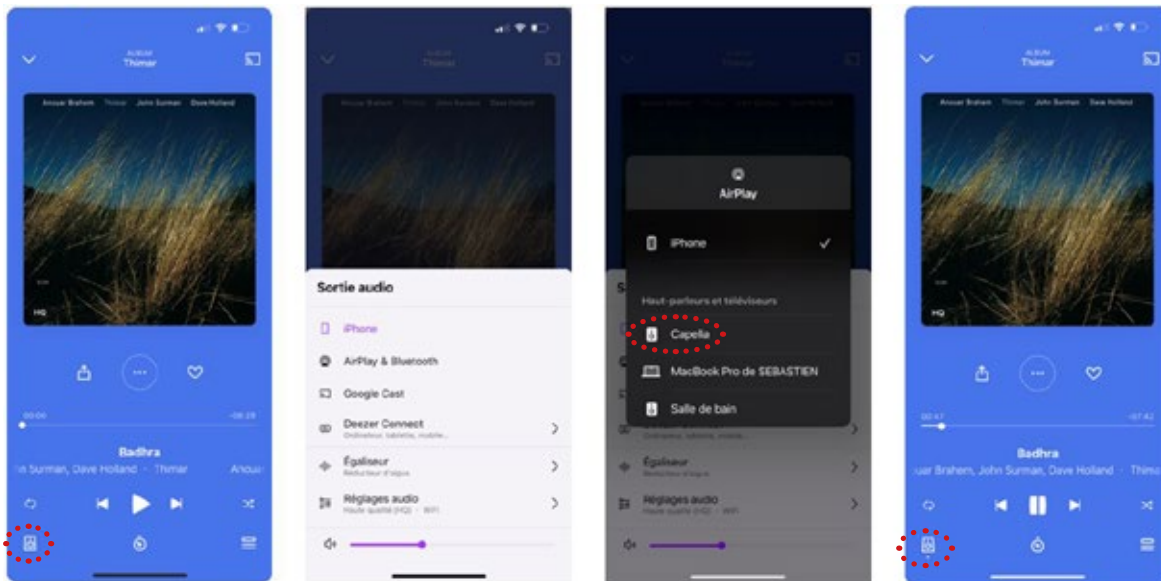

### ANDROID

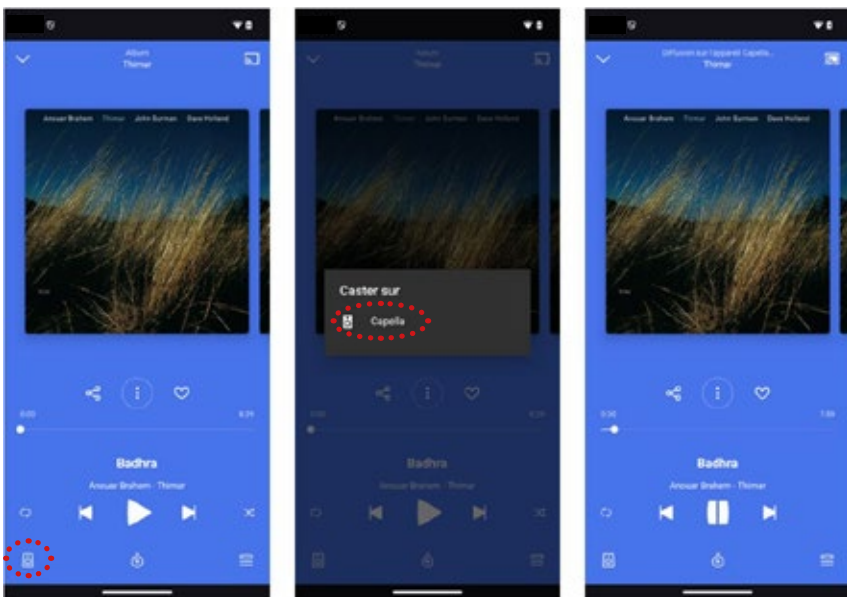

- Launch your Deezer app from your smartphone or tablet.
- Then click on the "📡" icon located on the lower left.
- Select "Airplay" or "Google Cast" as your connection mode.
- Select your CAPELLA system from the list.
- The "📡" icon on the lower left indicates that your system is connected.
- You can now start playing your track.

When using Airplay, if you select another source, the track is paused. Simply press Play in your Deezer app to restart the music, the Stereo Hub will automatically switch to this source.



With Google Cast, if you select another source on your Stereo Hub while listening to a streaming service, the music will automatically pause, and your speakers are disconnected. You will need to reconnect the speakers to your streaming service to restart the music.

## 10.A4 APPLE MUSIC

The Apple Music streaming service for owners of Apple smartphones/tablets works via Airplay.

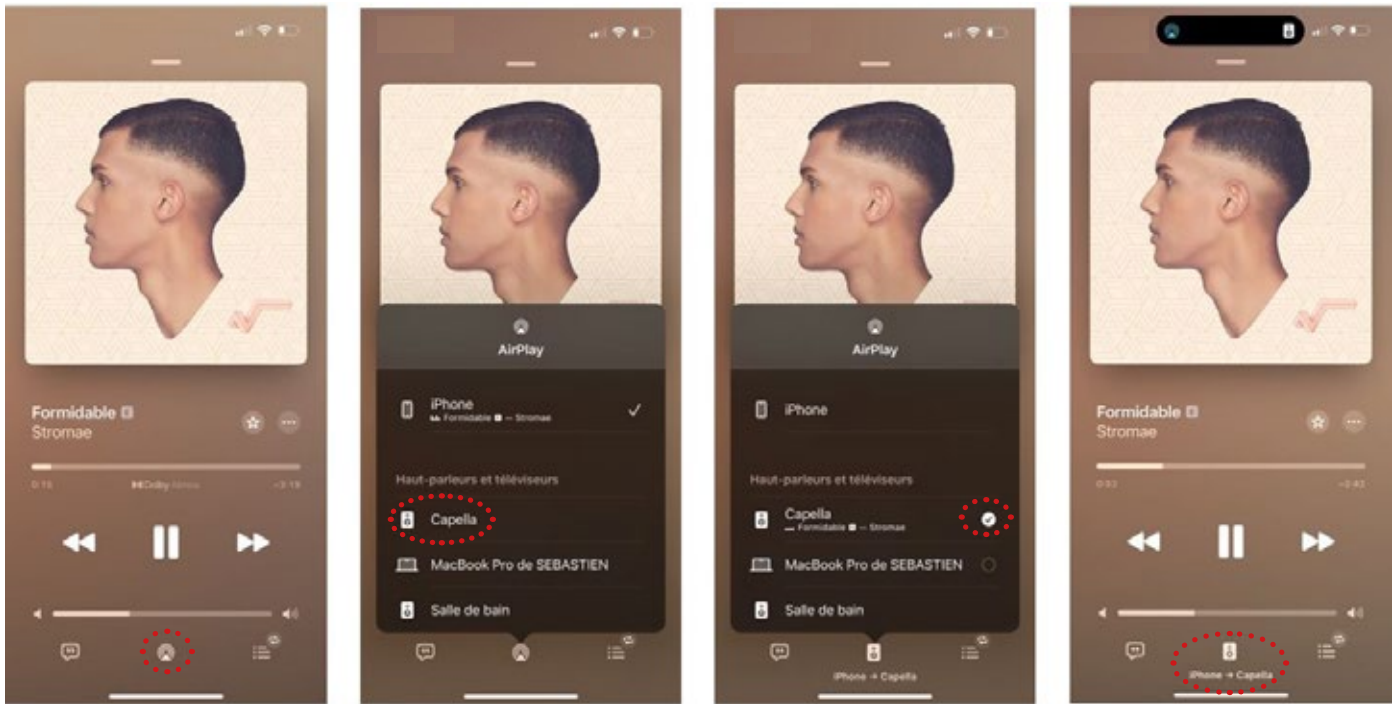
### APPLE



1. Launch your Apple Music app from your smartphone or tablet.
2. Then click on the "  " icon located in the bottom center.
3. Select your CAPELLA system from the list.
4. The icon "  " indicates that your system is connected.
5. You can now start playing your track.



If you select another source, the track is paused. Simply press Play in your Apple Music app to restart the music, the Stereo Hub will automatically switch to this source.

## 10.A5 QOBUZ

The Qobuz streaming service offers an Airplay or Google Cast connection on Apple. On Android, only the Google Cast connection is available.

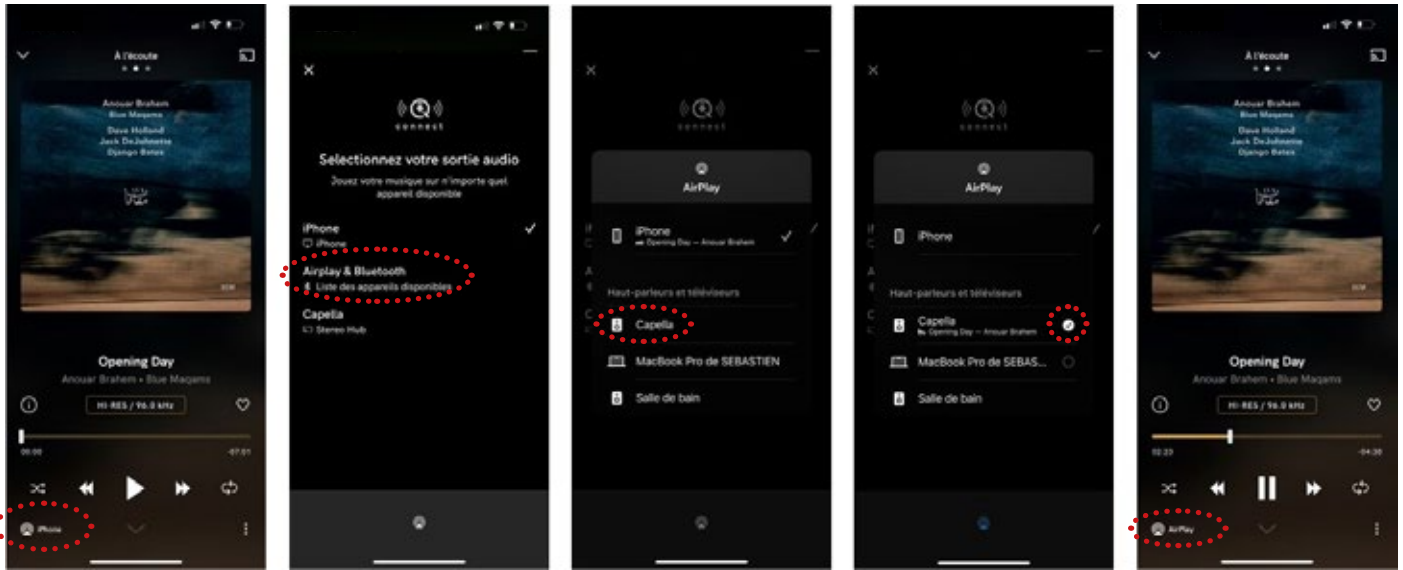
### APPLE



1. Launch your Qobuz app from your smartphone or tablet.
2. Then click on the "  " icon located on the lower left.
3. Select "Airplay" as your connection mode.
4. Select your CAPELLA system from the list.
5. The "  " icon on the lower left indicates that your system is connected.
6. You can now start playing your track.

If you select another source, the track is paused. Simply press Play in your Qobuz app to restart the music, the Stereo Hub will automatically switch to this source. The Google Cast connection is available from the "  " icon in the top right corner. If you choose this type of connection, please follow the Android instructions.  
Lancez votre application Qobuz depuis votre smartphone ou tablette.



## 10.A5 QOBUZ

### ANDROID

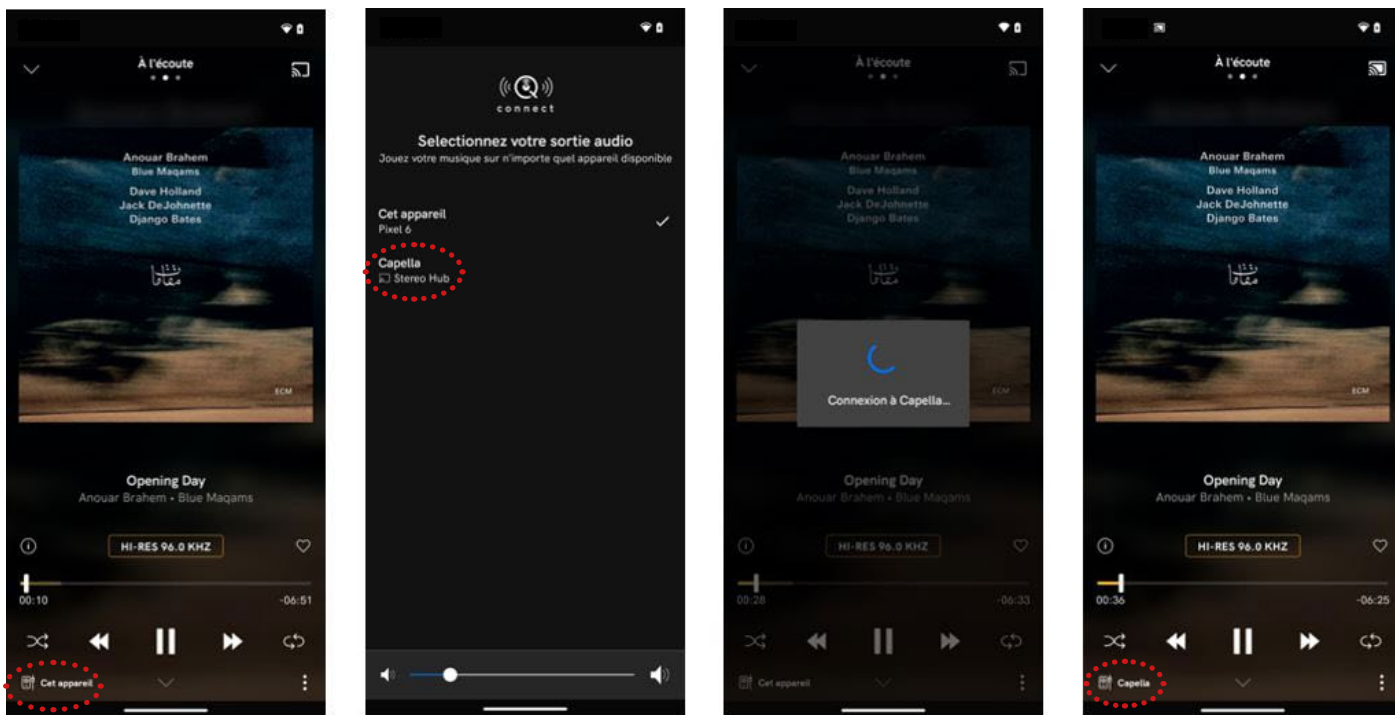

1. Launch your Qobuz app from your smartphone or tablet.
2. Then click on the "🔊" icon located on the top right.
3. Select your CAPELLA system from the list.
4. The "🔊 Capella" icon on the lower left indicates that your system is connected.
5. You can now start playing your track.

If you select another source, the track is paused. You will need to reconnect your speakers in your Qobuz app to restart the music.

Note: the music continues if you leave the Qobuz app, you can stop it from the CAPELLA app or by reopening your Qobuz app.

## 10.A6 TIDAL

The Qobuz streaming service offers an Airplay or Google Cast connection on Apple. On Android, only the Google Cast connection is available..

### APPLE

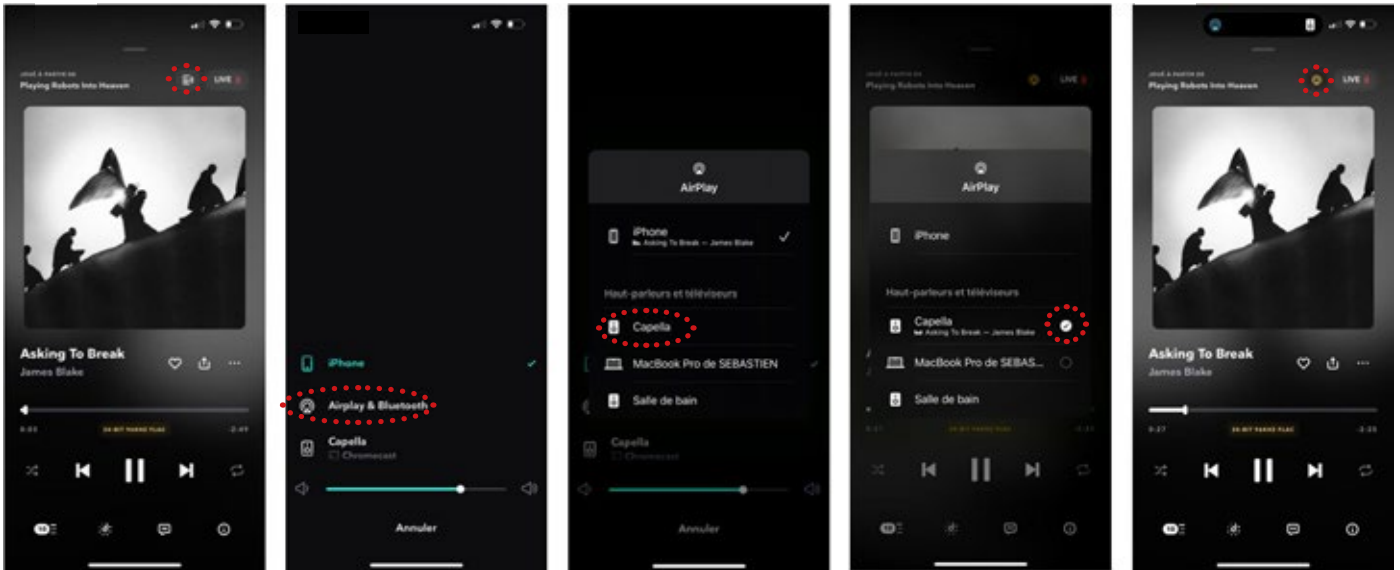

1. Launch your Tidal app from your smartphone or tablet.
2. Then click on the "  " icon located on the top right.
3. Select "Airplay" as your connection mode.
4. Select your CAPELLA system from the list.
5. You can now start playing your track.

If you select another source, the track is paused. Simply press Play in your Tidal app to restart the music, the Stereo Hub will automatically switch to this source.

The Google Cast connection is also available from the same "  " icon, if you choose this type of connection, please follow the Android instructions

## 10.A6 TIDAL

### ANDROID

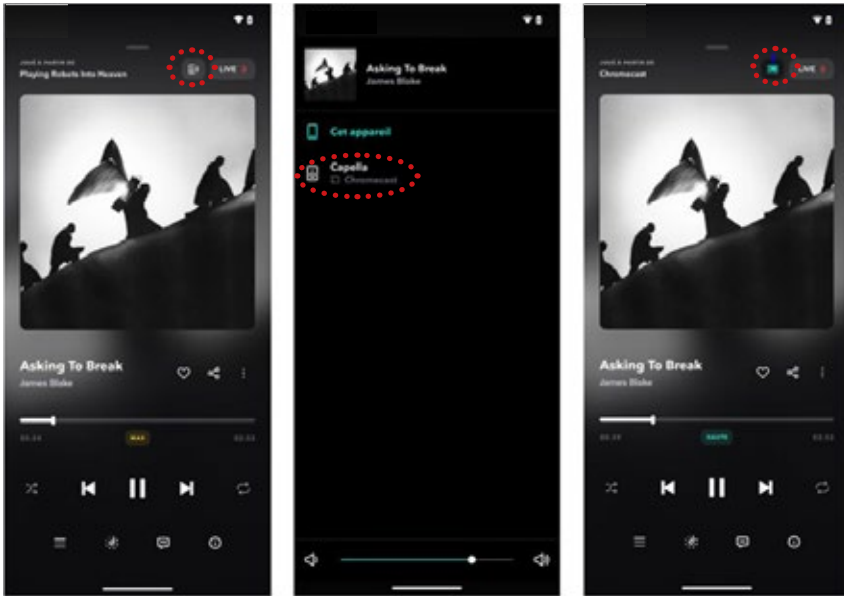

1. Launch your Tidal app from your smartphone or tablet.
2. Then click on the " " icon located on the top right.
3. Select your CAPELLA system from the list.
4. The " " icon on the upper right indicates that your system is connected.
5. You can now start playing your track.

If you select another source, the track is paused. You will need to reconnect your speakers in your Tidal app to restart the music.

Note: the music continues if you leave the Tidal app, you can stop it from this type of connection, please follow the Android instructions.

## 10.A7 AMAZON MUSIC

The Amazon Music streaming service offers an Airplay or Google Cast connection on Apple. On Android, only the Google Cast connection is available.

### APPLE

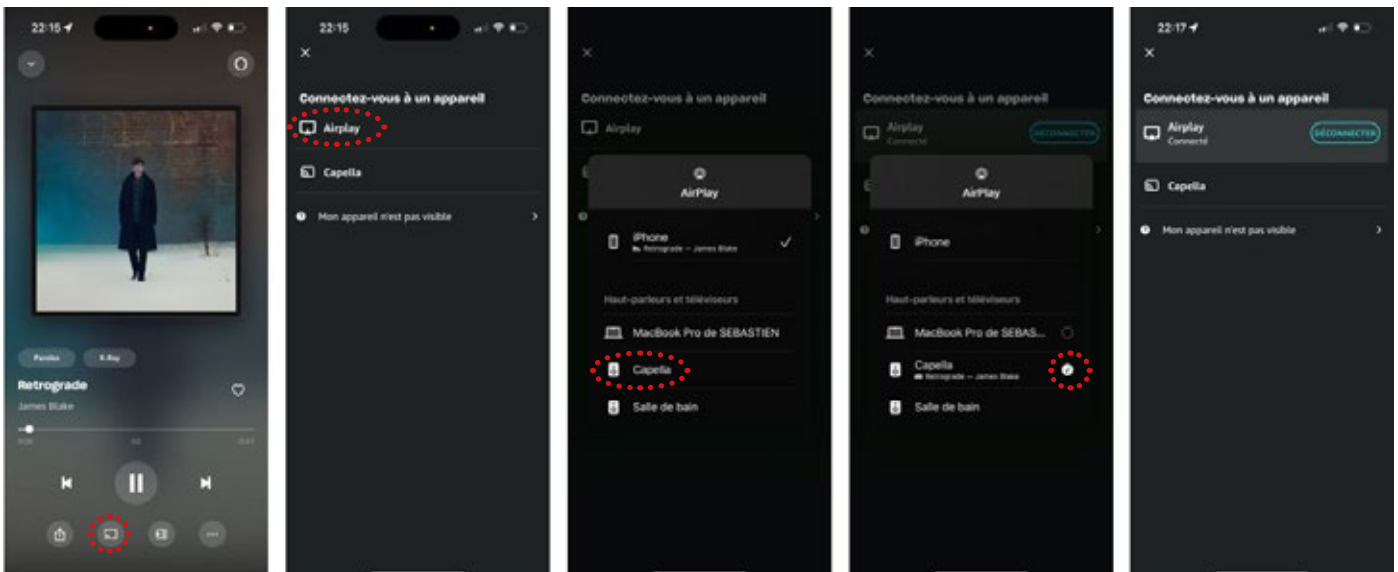

1. Launch your Amazon Music app from your smartphone or tablet.
2. Then click on the "  " icon located in the bottom center.
3. Select "Airplay" as your connection mode.
4. Select your CAPELLA system from the list.
5. You can now start playing your track.



If you select another source, the track is paused. Simply press Play in your Amazon Music app to restart the music, the Stereo Hub will automatically switch to this source.

The Google Cast connection is also available from the "  " icon in the bottom center. If you choose this type of connection, please follow the Android instructions.

## 10.A7 AMAZON MUSIC

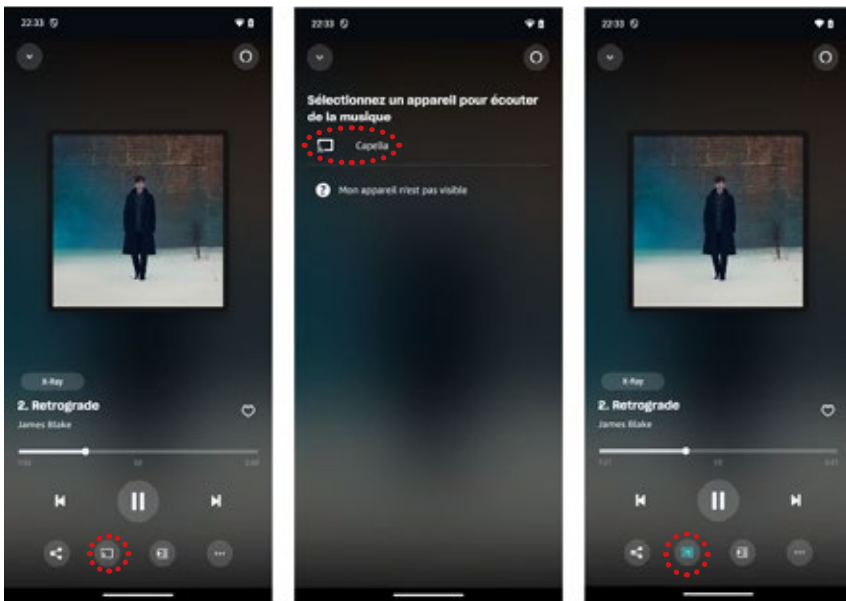
### ANDROID



1. Launch your Amazon Music app from your smartphone or tablet.
2. Then click on the "  " icon located in the bottom center.
3. Select your CAPELLA system from the list.
4. The "  " icon in the bottom center indicates that your system is connected.
5. You can now start playing your track.

If you select another source, the track is paused. You will need to reconnect your speakers in your Amazon Music app to restart the music.

Note: the music continues if you leave the Amazon Music app, you can stop it from the CAPELLA app or by reopening your Amazon Music app.

## 10.A8 YOUTUBE MUSIC

The YouTube Music streaming service offers an Airplay or Google Cast connection on Apple. On Android, only the Google Cast connection is available.

### APPLE

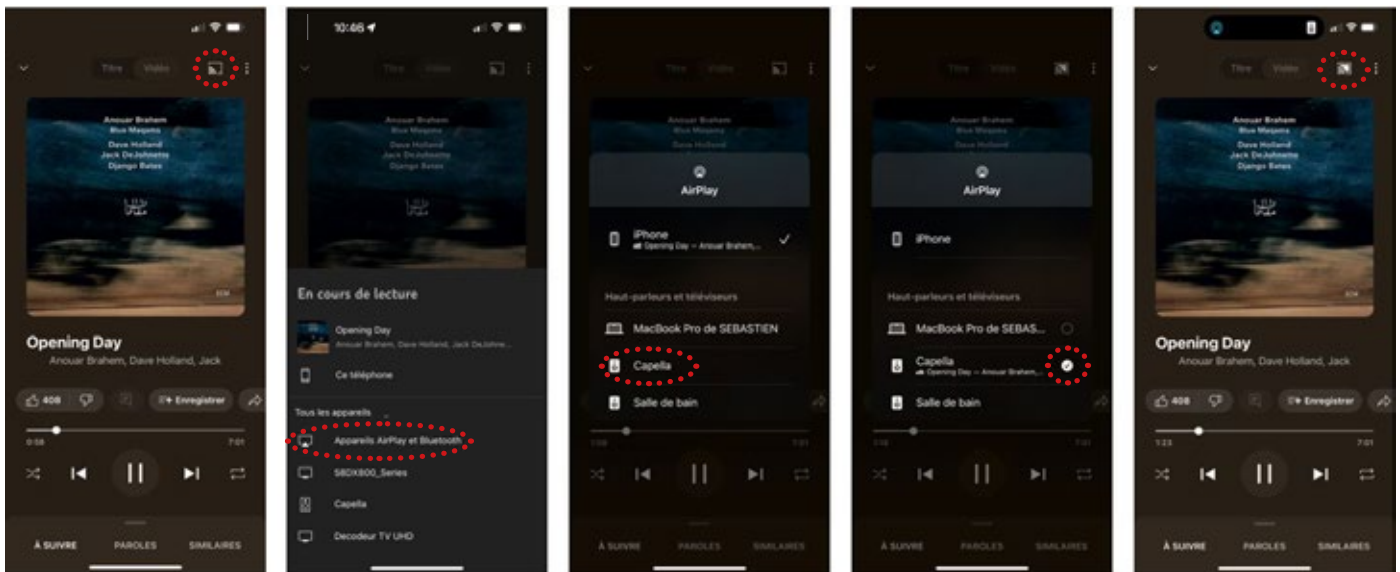

1. Launch your YouTube Music app from your smartphone or tablet.
2. Then click on the “” icon located on the top right.
3. Select “Airplay” as your connection mode.
4. Select your CAPELLA system from the list.
5. You can now start playing your track.



If you select another source, the track is paused. Simply press Play in your YouTube app to restart the music, the Stereo Hub will automatically switch to this source.

The Google Cast connection is also available from the same “” icon, if you choose this type of connection, please follow the Android instructions.

## 10.A8 YOUTUBE MUSIC

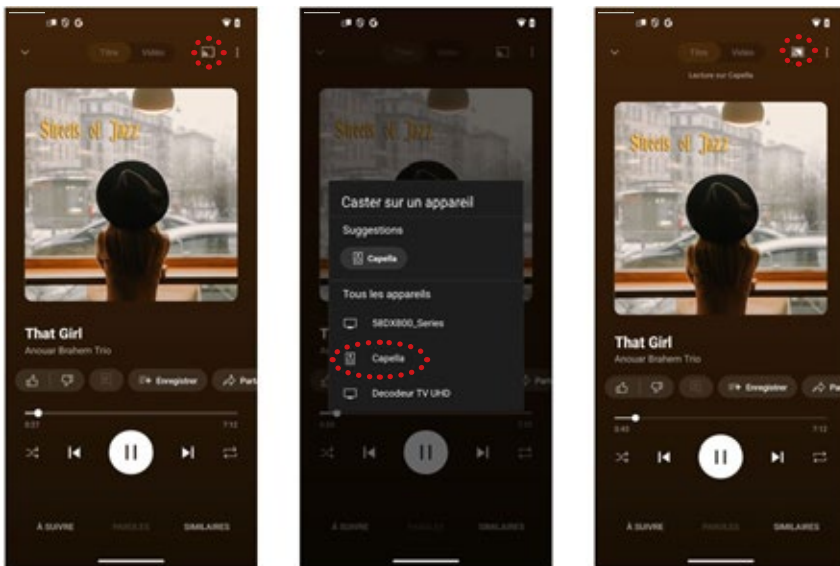
### ANDROID



1. Launch your YouTube Music app from your smartphone or tablet.
2. Then click on the "  " icon located on the top right.
3. Select your CAPELLA system from the list.
4. The "  " icon on the upper right indicates that your system is connected.
5. You can now start playing your track.

If you select another source, the track is paused. You will need to reconnect your speakers in your YouTube Music app to restart the music.

Note: the music continues if you leave the YouTube Music app, you can stop it from the CAPELLA app or by reopening your YouTube Music app.

## 9.A9 YOUTUBE VIDEO

The YouTube streaming service offers an Airplay connection for Apple only.

### APPLE

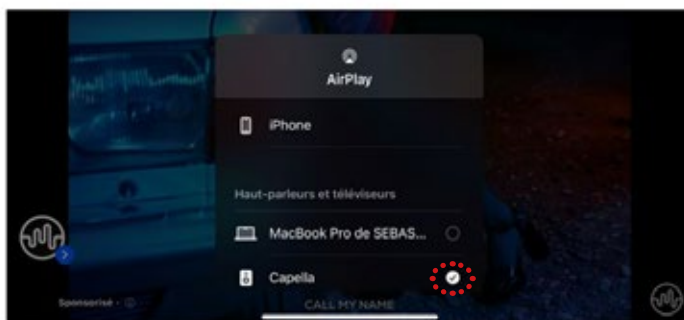
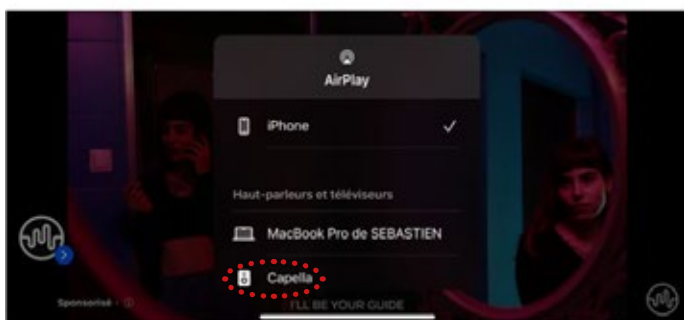
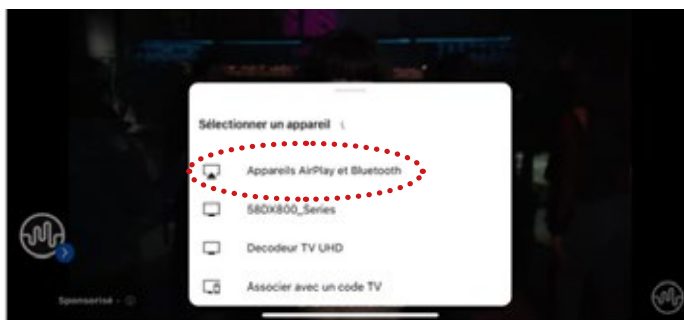
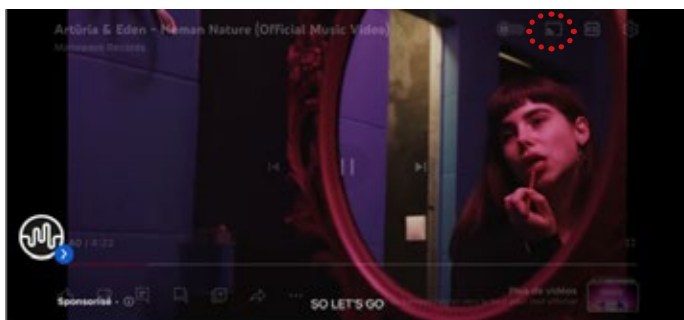

1. Launch your YouTube app from your smartphone or tablet.
2. Then click on the "  " icon located on the top right.
3. Select "Airplay" as your connection mode.
4. Select your CAPELLA system from the list.
5. You can now start playing your video.

If you select another source, the track is paused. Simply press Play in your YouTube app to restart the music, the Stereo Hub will automatically switch to this source.



## 10.A10 TUNE IN

The online radios and TuneIn service offer an Airplay or Google Cast connection on Apple. On Android, only the Google Cast connection is available.

### APPLE

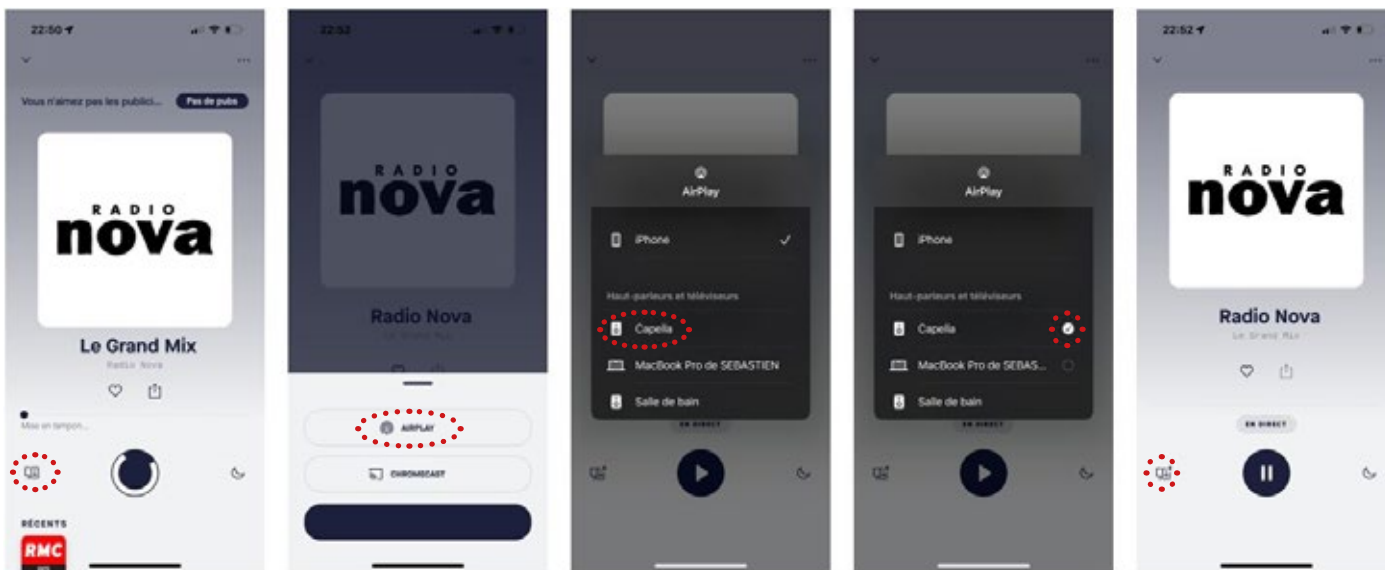

1. Launch your TuneIn app from your smartphone or tablet.
2. Then click on the "  " icon located on the lower left.
3. Select "Airplay" as your connection mode.
4. Select your CAPELLA system from the list.
5. You can now listen to your radio station on your CAPELLA system.



If you select another source, you will have to return to the Wi-Fi source to continue listening.

The Google Cast connection is also available from the same icon, if you choose this type of connection, please follow the Android instructions.

## 10.A10 TUNE IN

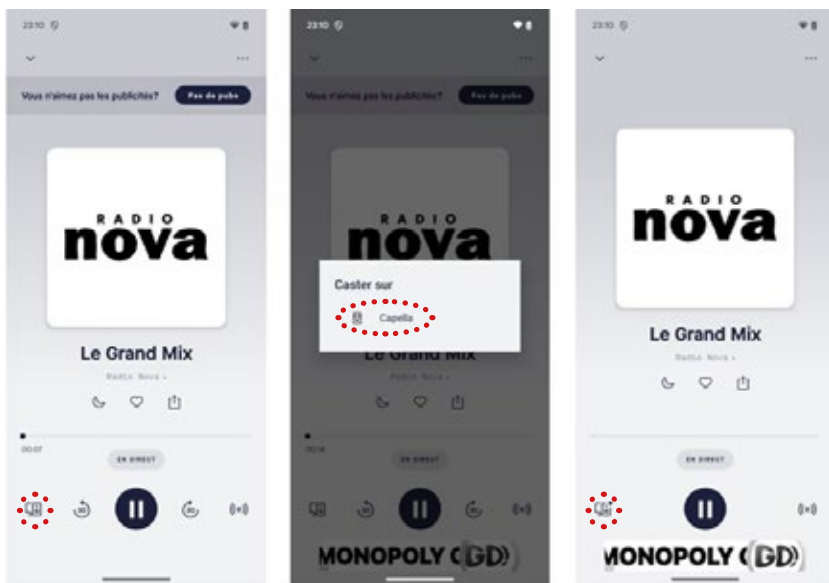
### ANDROID



1. Launch your Tuneln app from your smartphone or tablet.
2. Then click on the "  " icon located on the lower left.
3. Select your CAPELLA system from the list.
4. The "  " icon on the lower left indicates that your system is connected.
5. You can now start playing your track.

If you select another source, you will have to return to the Wi-Fi source to continue listening.

Note: the radio continues if you leave the Tuneln app, you can stop it from the CAPELLA app or by reopening your Tuneln app.

## 10.B CONNECTION VIA BLUETOOTH

Sampling: 48kHz/16bits

With this connection, you can send music wirelessly using Bluetooth technology. The CAPELLA System Lets you play music from any Bluetooth-enabled source: smartphone, tablet, computer... To do so:

Switch on your CAPELLA system by pressing  on your remote control.

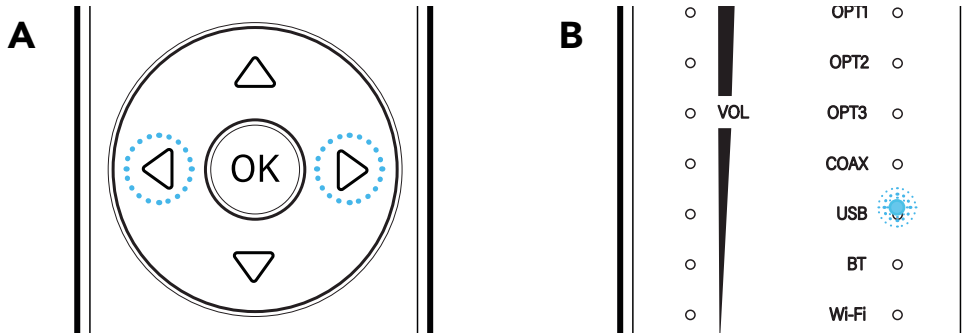

- Select the Bluetooth input using the horizontal arrows (A) on your remote control. The indicator light in front of "BT" lights up white (B).
- Run a search on your Bluetooth device (refer to the user manual if necessary), then look for the device "Stereo\_Hub2cXXX" or the name defined during Wi-Fi configuration. Connect to the Stereo Hub.
- With the Stereo Hub's remote control, you can change track, as well as pause and play your track.
- You can adjust the volume of the CAPELLA system from your Bluetooth source using the physical buttons on your device, or directly from the music application you are using.
- When connecting a Bluetooth device with a volume control, be careful of the volume level. If the level is too low, the CAPELLA speakers will not be audible. We recommend setting the Bluetooth device volume to 75% and the speaker volume to minimum, then gradually increasing the volume from the remote control.

A function is available to hide the Bluetooth network so your neighbors cannot connect to it:

- Press the "previous" button on your remote control for 3 seconds.
- To make it reappear, press the "Next" button on your remote control for 3 seconds.
- This operation can also be performed directly from the app:

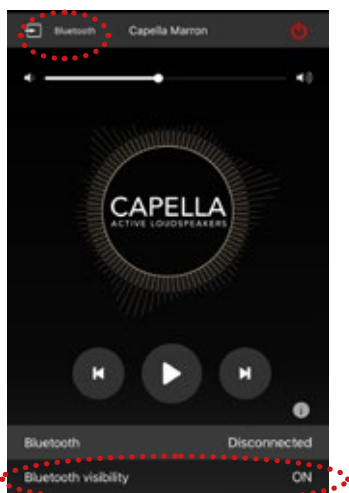

## 10.C CONNECTION VIA HDMI

Sampling: 192kHz/24bits

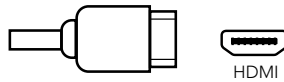

The HDMI input connects your TV to your Stereo Hub. To do so:

- ▶ Make sure your TV and your HDMI cable are compatible with the HDMI ARC technology.
- ▶ Then connect your HDMI cable to the input of your Stereo Hub and to the HDMI ARC input of your TV.
- ▶ In your TV settings, set the sound output to PCM (Stereo).

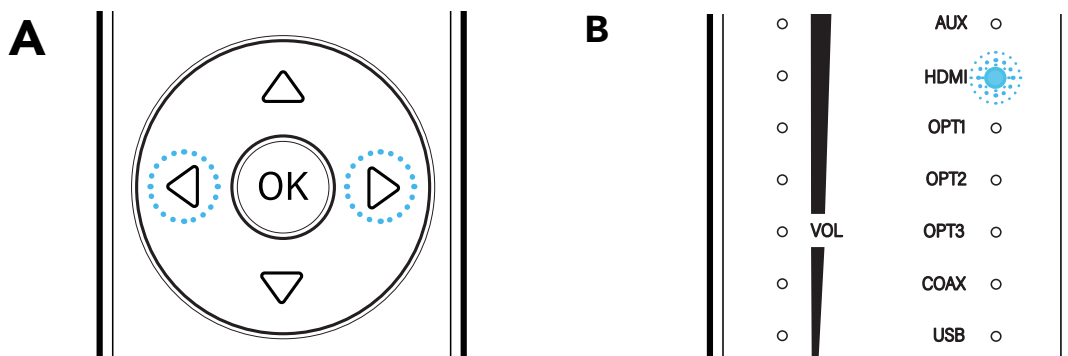

- ▶ Select the HDMI input using the horizontal arrows (A) on your remote control. The Indicator light in front of "HDMI" lights up white (B).

Your system is ready to operate.



This connection allows you to switch on your speakers at the same time as your TV and control the speaker volume via your TV remote control. Compatibility with CEC functions may differ depending on your TV model or brand.

## 10.D CONNECTION VIA USB

Sampling: 192kHz/24bits

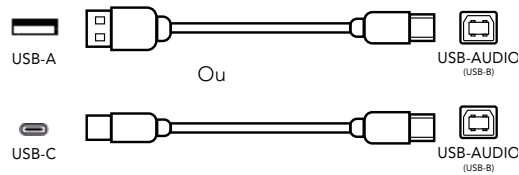

The USB-AUDIO input allows you to connect your Stereo Hub to a computer. You can use a USB-A or USB-C to USB-B cable.

- ▶ Connect the USB cable between your Stereo Hub and your computer.
- ▶ Select the USB input using the horizontal arrows (A) on your remote control. The indicator light in front of "USB" lights up white (B).

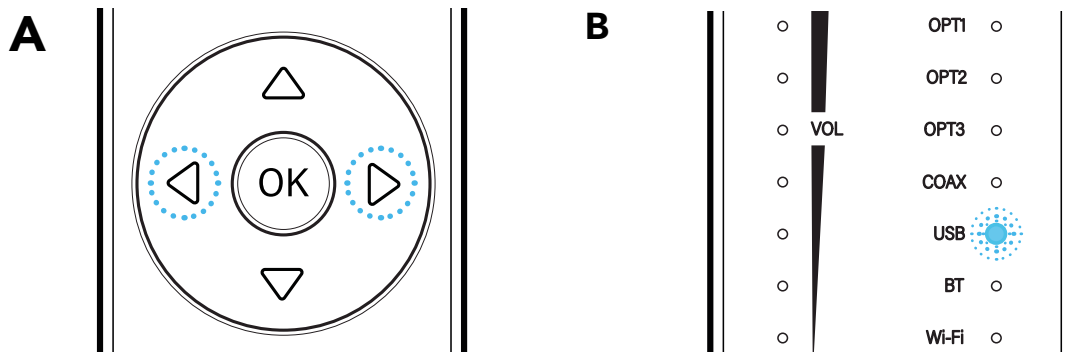

- ▶ In your computer settings, select the "Stereo Hub" speakers as the audio output.
- ▶ Your system is ready to operate



The USB input volume is set to the maximum level by default. To enable this function, simply press the "Mute" button for 5 sec. (See page 9)

## 10.E1 CONNECTION VIA AN OPTICAL CABLE

Sampling: 192kHz/24bits

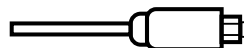

The 3 optical inputs (OPT1) allow you to connect audio devices with optical outputs to your Stereo Hub: TV, CD player, DVD player...

To do so:

- ▶ Connect your optical cable from the rear of the Stereo Hub to the "OPTICAL" input on your device.
- ▶ In your device settings, set sound output to PCM (Stereo).
- ▶ Select the Optical input using the horizontal arrows (A) on your remote control. The indicator light in front of "USB" lights up white (B).

Your system is ready to operate.

## 10.E2 CONNECTION VIA A COAX CABLE

Sampling: 192kHz/24bits



L'entrée coaxiale (COAX) permet de connecter tous les périphériques audio disposant d'une sortie coaxiale à votre Stéréo Hub: platine CD, lecteur DVD/Blu-ray, télévision...

Pour cela :

- ▶ Connectez votre câble coaxial entre votre Stéréo Hub et votre périphérique.
- ▶ Sélectionnez l'entrée coaxiale à l'aide des flèches horizontales (A) de votre télécommande. Le témoin lumineux devant «USB» s'illumine en blanc (B).
- ▶ Votre système est alors prêt à fonctionner.

## 10.E3 CONNECTION VIA A 1/8-INCH (3.5MM) JACK / OPTICAL CABLE

Sampling: 192kHz/24bits

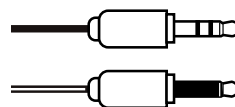

The Auxiliary input (AUX) lets you connect various devices with a mini-Jack (3.5mm) or optical output to your Stereo Hub: smartphone, audio player, tablet, computer, television...

To do so:

- ▶ Plug one end of the jack connector into the "AUX" input and the opposite end into your device.
- ▶ Select the Auxiliary input using the horizontal arrows (A) on your remote control. The indicator light in front of "USB" lights up white (B).
- ▶ Your system is ready to operate

## 10.F CONNECTION VIA RCA (TURNTABLE/ CD PLAYER/...)

Optical sampling: 96kHz/24bits

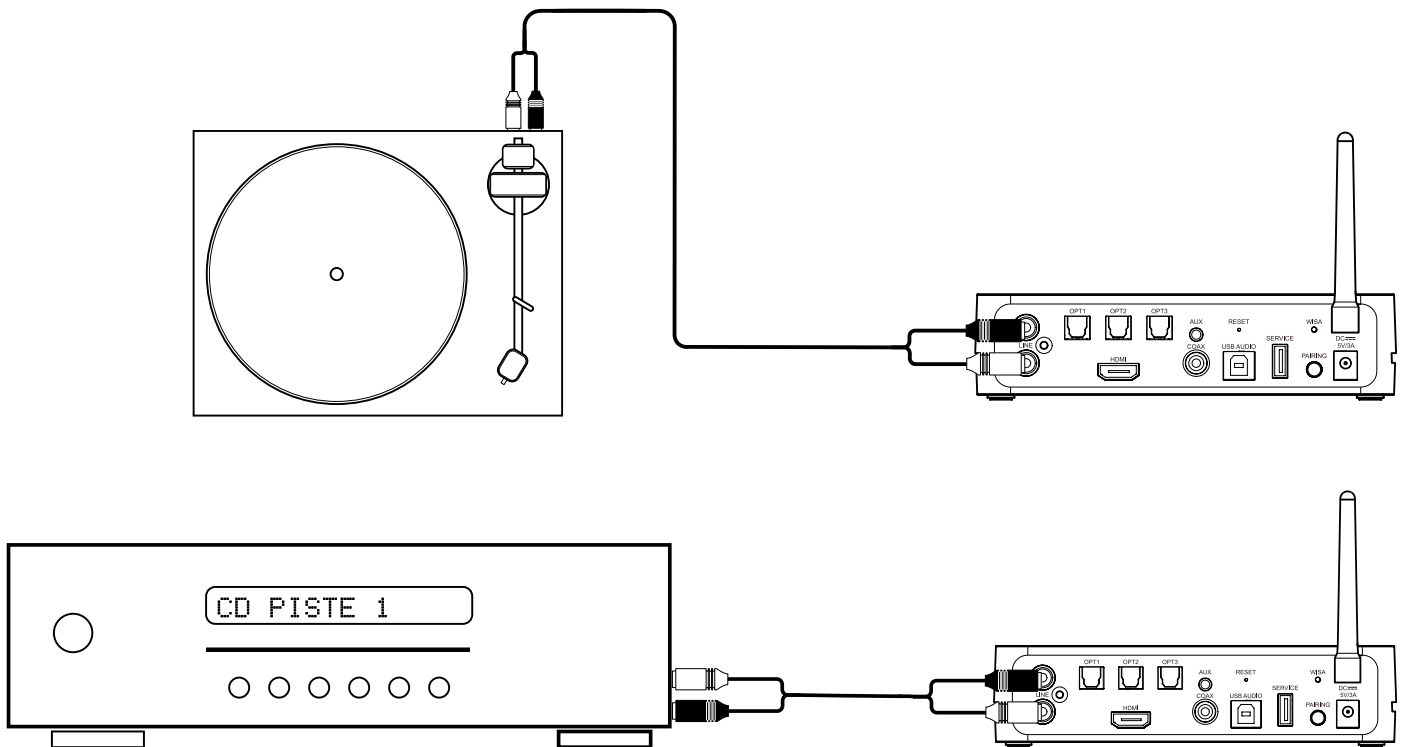

The LINE input can be used to connect a pre-amplified turntable, CD player or any other source with RCA outputs.

- ▶ Connect the source's RCA cable to the "Line" input of your Stereo Hub.
- ▶ Select the Line input using the horizontal arrows (A) on your remote control. The indicator light in front of "USB" lights up white (B).
- ▶ Your system is ready to operate.



When connecting a turntable, the Stereo Hub MUST be switched off.

.The turntable must be pre-amplified, CHECK COMPATIBILITY

# 11. CONNECTING SOURCES WITHOUT THE STEREO HUB

## 11.A CONNECTION VIA RCA SOURCE

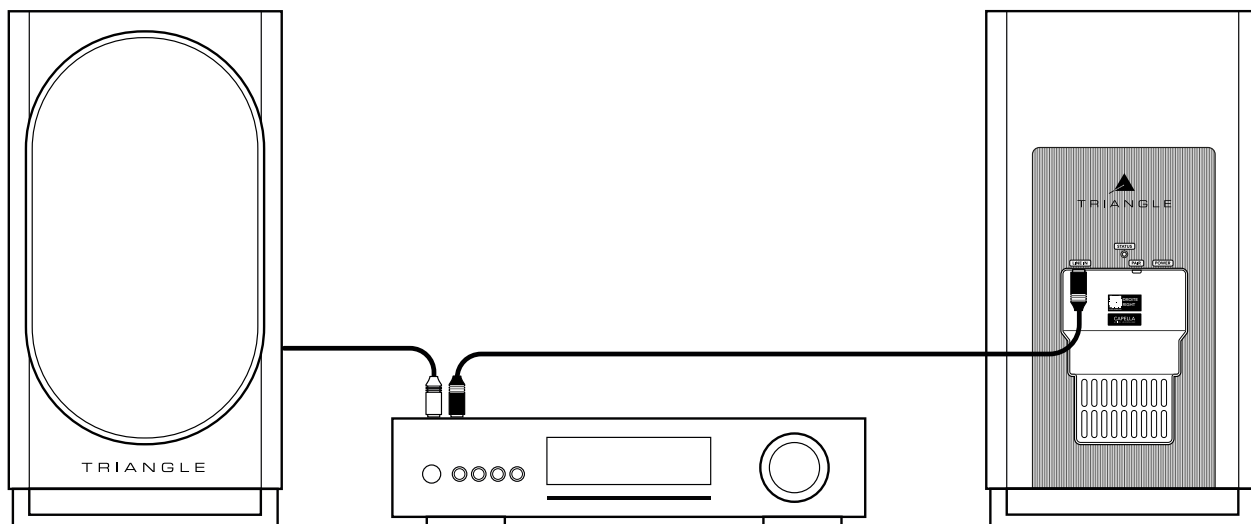

Use the “pre-amp” output of your integrated amplifier or the “amp” output of your preamp:

- ▶ Connect the source’s RCA cables to the “Line IN” input of the speakers.
- ▶ The red RCA indicates the right speaker, the black or white RCA the left speaker.
- ▶ Your system is ready to operate.

In this configuration, EQ settings will no longer be available from the app.

When a connection is detected on the RCA connectors, the speaker automatically switches to this input, and the status LED on the speaker turns green.



.....  
Your source needs to have built-in volume management so you can control it.  
.....



## 11.B CONNECTION VIA WiSA SOURCE

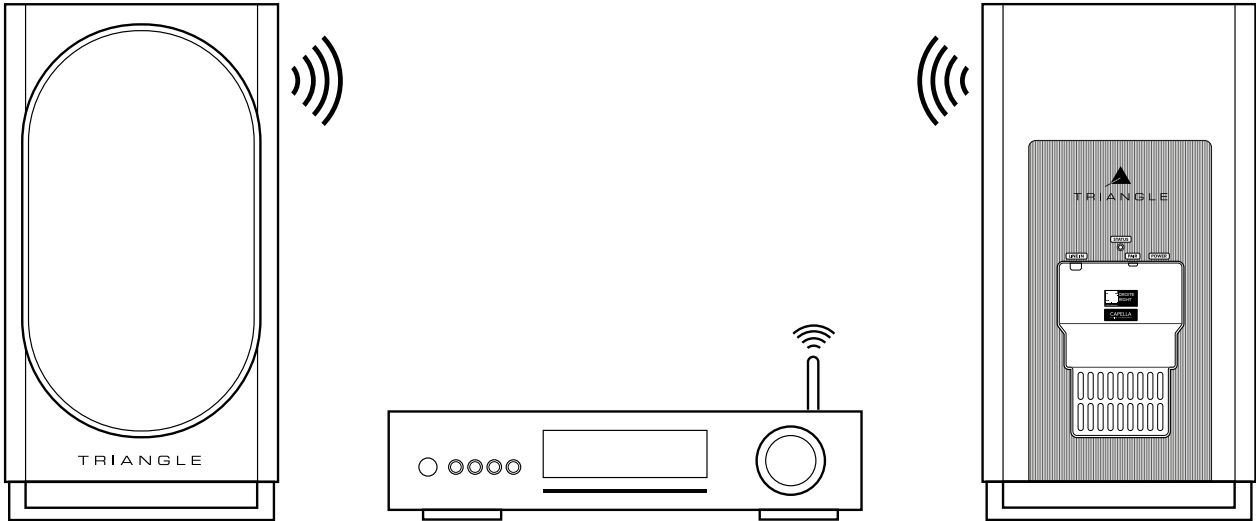

Some sources, like TVs/streamers/consoles, have WiSA compatibility.

This means you do not need the Stereo Hub and can connect your source directly to your speakers.

To do this:

- ▶ Connect your speakers using the supplied power cables.
- ▶ The STATUS LED on the rear of your speakers lights up:
  - ▶ 1 orange flash
  - ▶ then turns puis devient blue
  - ▶ and finally turns off indicating the end of the process (wait 1mn before the LED goes out). Press the "PAIR" button on each speaker for 3-4 seconds, then wait for the LEDs to start flashing orange rapidly.
- ▶ Press once the "PAIRING" button on the source.
- ▶ Pairing is confirmed once the LEDs on both speakers are lit continuously..
- ▶ By default, your speakers are set as Left channels. To revert to stereo, see **p.13**.



.....  
Your source needs to have built-in volume management so you can control it.  
.....

# 12.APPENDIX

## APPENDIX 1: CONNECTING THE STEREO HUB TO THE WI-FI VIA

Here is another method to connect your CAPELLA system to the Wi-Fi if your region does not allow the use of Google-Home



**WARNING:** the Google Cast connection will not be supported, only AirPlay connections and the Spotify Connect and Roon Ready streaming services work with this method.

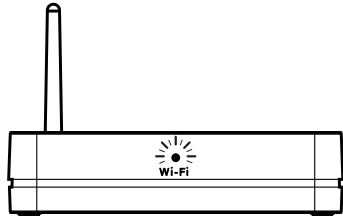

1. The Wi-Fi LED on the front flashes rapidly, indicating the "Wi-Fi configuration" mode is activated.

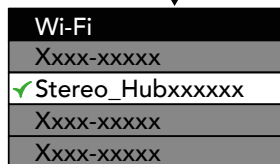
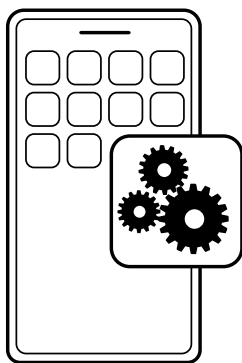

2. Go to the Wi-Fi settings on your smartphone/tablet/computer, then connect to the "Stereo\_Hub2CXXXX" network.

\* Please note that two networks appear. Be sure to select the «Stereo\_Hub2C6210» network type without extension.

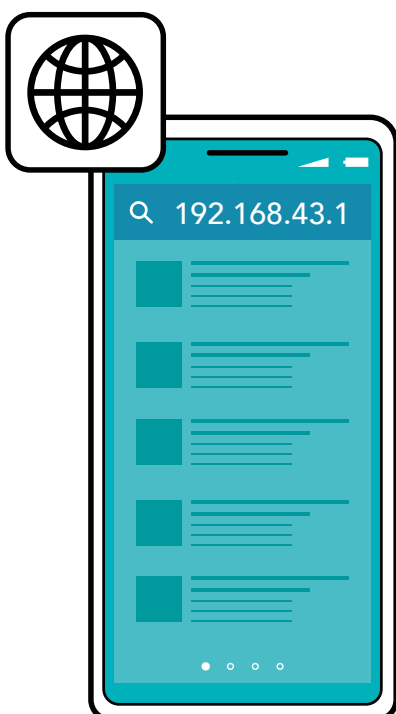

3. Then open your web browser and type the following IP address in your search bar: 192.168.43.1 then confirm.

# APPENDIX 1: CONNECTING THE STEREO HUB TO THE WI-FI VIA THE IP

4. You will be taken to the next page where two actions are requested:

a. Customize your system name :

192.168.43.1

---

Device Name  Airplay password

Network  Password

Configure Manually  Static IP

Apply Save

1. Enter the name of your choice in this field (e.g. "TRIANGLE CAPELLA"). This name will appear on your Wi-Fi or Bluetooth connections.

2. Click on "Apply", then refresh the page 192.168.43.1 in the search bar of your browser

b. Connect your Stereo Hub to your network :

192.168.43.1

---

Device Name  Airplay password

Network  Password

Configure Manually  Static IP

Apply Save

..... 1. Choose your home network from the list

..... 2. Enter your network password.

3. Click "Save".

Your speakers are now connected to your network. Go to page 24 to finish installing the Capella app.

## APPENDIX 2: ZEN MICROPHONE

For the best measurement results, we recommend using the ZEN microphone with Bluetooth & Wi-Fi wireless technology. This microphone is compatible with Apple & Android smartphones. It collects the data, then transmits it to the CAPELLA app to analyze and calculate the correction to be made.

\*However, it is possible to take measurements directly from an iPhone superior to the 6s generation.

\*For Android users, the ZEN microphone is required. It can be purchased on our TRIANGLE website ([www.trianglehifi.com](http://www.trianglehifi.com)) or from your local dealer.

### Description of the functions :

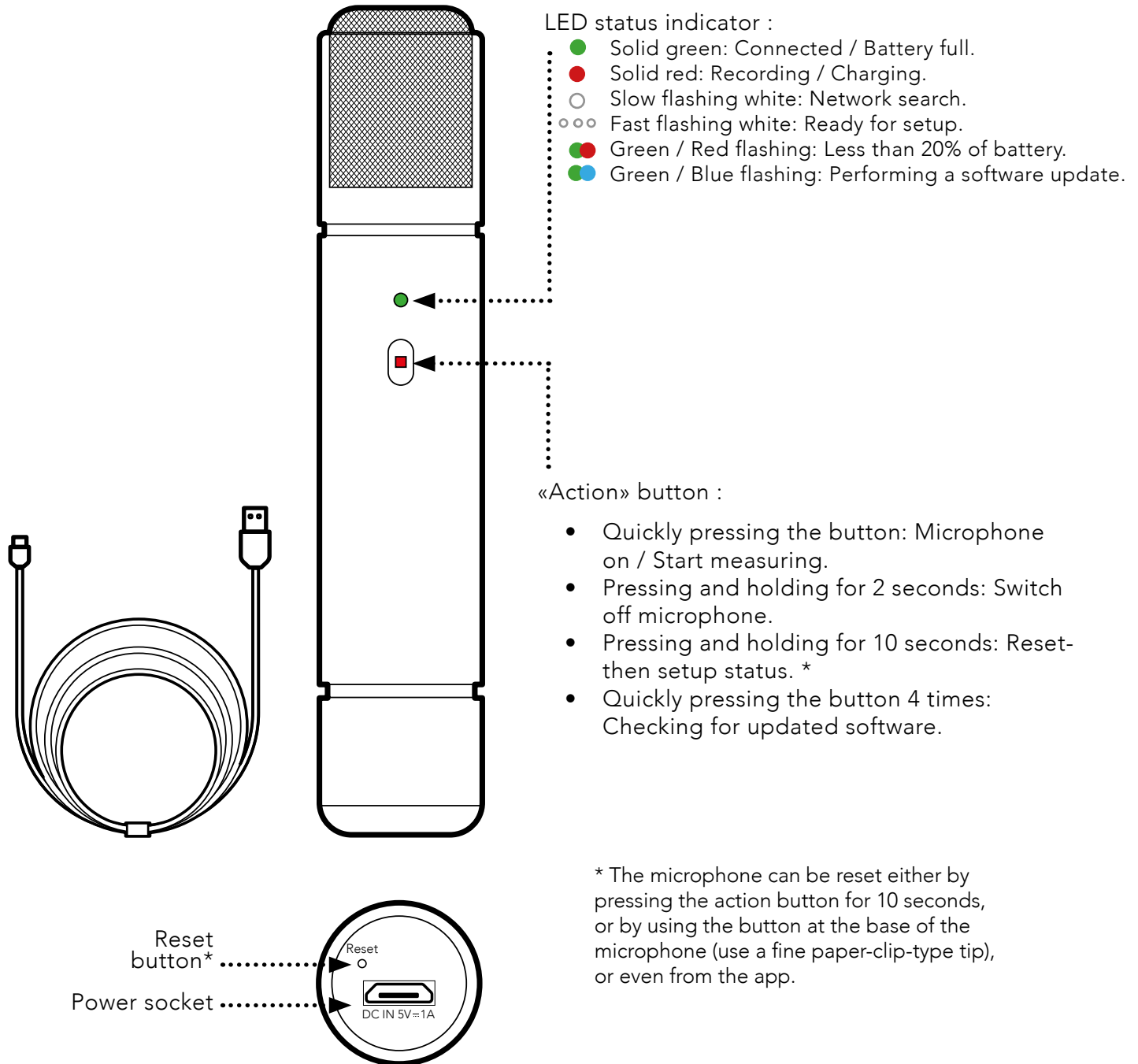

The ZEN microphone is supplied with its USB charging cable. We recommend ensuring that it is fully loaded before proceeding to the next step. To do so, connect the cable between your microphone and a USB port, then wait for the LED to turn green, indicating that the battery is fully charged.

## APPENDIX 2: ZEN MICROPHONE

### Installation :

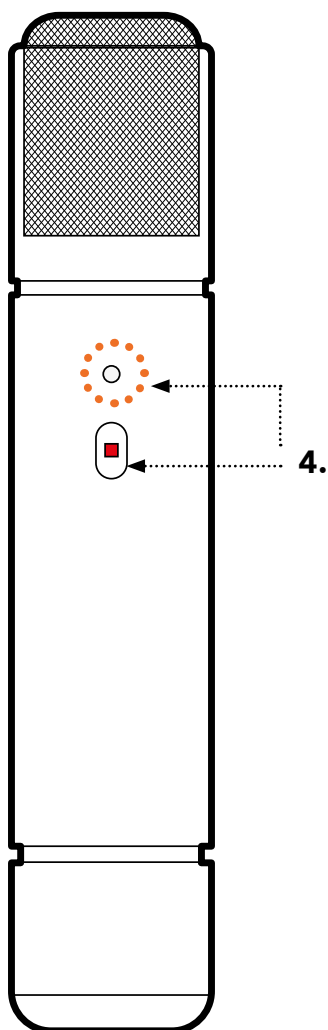

5.

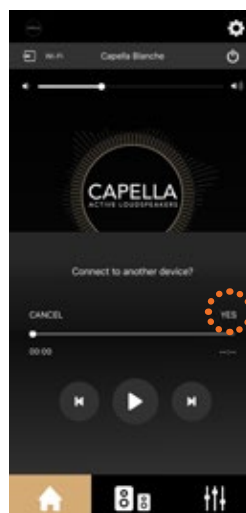



6.

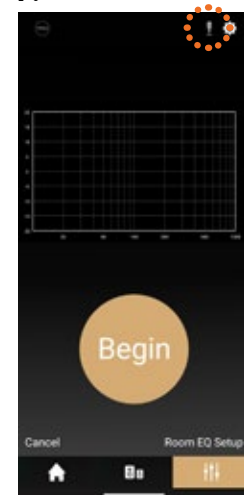

7.



1. Make sure your CAPELLA system is On and connected to the Wi-Fi network.
2. Switch on your ZEN microphone by simply pressing the "Action" button (make sure it is properly charged beforehand). The white LED flashes rapidly, indicating that the microphone is ready for setup.  
(\* if not, press and hold the "Action" button for 10 seconds to reset the microphone)
3. Start your CAPELLA app.
4. Confirm the connection of a new device on the app.
5. Select your Wi-Fi network and enter the corresponding Wi-Fi password. Then press "CONNECT".
6. The app restarts. Select your CAPELLA system and go back to the EQ page.
7. The microphone  appears in the top right-hand corner, next to the parameters icon  on the EQ page.
8. Refer to page 28 to make the "Room EQ" measurements.
9. The status of your ZEN microphone is available in the app settings. You can rename it, reset it, check its battery level and check the latest update.

\*The microphone switches off automatically after 10 minutes of inactivity.

## APPENDIX 3: LEFT AND RIGHT SPEAKER ASSIGNMENT

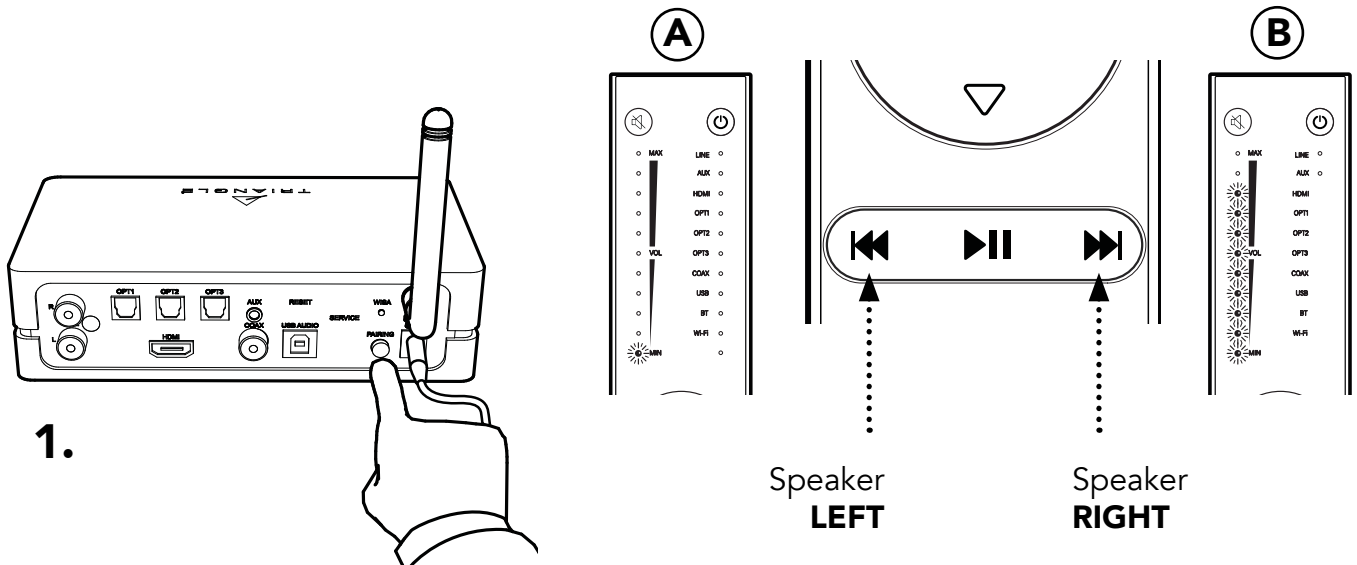

1. Press and release three times quickly the "PAIRING" button on the back of the Stereo Hub until the WiSA LED starts flashing rapidly. The "stereo configuration mode" is activated when you hear a sound like "psst!" on one of your speakers.

2. Press the button on your remote control corresponding to the sound-emitting speaker, as shown in the diagram. One LED lights up for the left speaker (A), then nine for the right speaker (B) on the remote control

3. Press the left or right source selection arrow to switch to the second speaker, then repeat the operation on the remote control.

4. Once the left and right channels have been defined, exit the "Stereo configuration mode" by pressing the button .

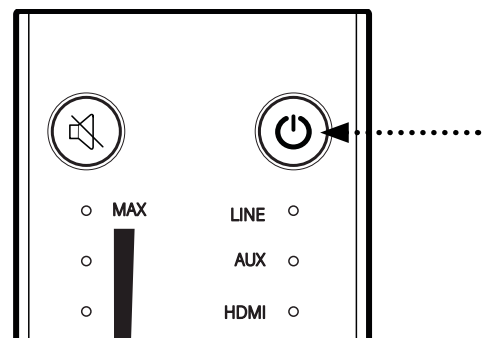

# CAPELLA

Technical specifications	CAPELLA System
Type	Bass-reflex active speaker
Driver diameters	Tweeter with a 1 inch magnesium alloy dome 6 inch midrange/bass driver in cellulose pulp
Bandwidth	42 Hz - 22 KHz
System power	2 x 100W
Stereo Hub inputs	RCA x1 / Optique x3 / USB audio x1 / Aux jack - optique x1 / HDMI (ARC-CEC) x1 / Coax x1  Streaming: Bluetooth 4.2 / Google Cast / Airplay / Spotify connect / Roon ready / DLNA UpNP
CAPELLA inputs	WiSA / RCA
Audio format	MP3, WMA, APE, FLAC, WAV, Apple Lossless
Dimensions (LxHxP)	7.87x 14.96 x 12.4 inch
Net weight of the active speakers Net weight of the Stereo Hub	18.7 lbs 1.1 lbs
Shipping weight with packaging	50.59 lbs





**HOW TO CONTACT US?**  
CAPELLA@trianglehifi.com

## SAFETY INSTRUCTIONS

**WARNING: Read carefully all the safety instructions before using the device .**

- Keep these safety instructions for future reference.
- Do not use this apparatus near water or liquid.
- Only clean with a dry and soft cloth.
- Make sure the openings (vents) on the device are not blocked.
- • Do not install near any heat sources such as radiators, stoves, or any other apparatus (including amplifiers) that produce heat.
- Only use accessories specified by the manufacturer.
- Be sure that the stand/table/furniture is strong enough to support the apparatus (stand, shelf, furniture...).
- Protect the power cable from being pinched or crushed, in particular around the plugs, and also protect the power inlet on the apparatus.
- Unplug the apparatus during lightning storms or when it's unused for long periods of time.
- The plug of the apparatus must fit with the outlet. Never tamper with the plug in any way. The apparatus should be Connected to a mains socket outlet with protective earthing connection.
- Refer to your authorized TRIANGLE dealer if the apparatus is damaged in any way. For example, if the power cord or the wall outlet is damaged, liquid has been spilled or objects have fallen on the apparatus, the apparatus has been exposed to rain or moisture, does not operate normally, or has been dropped.



# WARRANTY

---

## Thanks for buying a TRIANGLE CAPELLA system.

We want you to enjoy your purchase to the fullest. The first step is an easy registration of your products. By doing this, you will benefit from helpful tips, products support, special offers and 1-year additional warranty on your TRIANGLE speakers.

## Register online

Register your product for free directly on our website: <http://register.trianglehifi.com/>

---

## Note on the warranty

Your TRIANGLE loudspeakers are warranted for 2 years. This warranty takes effect from the date of purchase and covers any manufacturing defect or damage your loudspeakers could suffer as a result of these same defects. This warranty is granted solely to the first owner of the product, and is not transmittable in the case of resale. To validate your warranty, you will need to register online or mail the warranty coupon to TRIANGLE. It is not transmittable in the case of resale. Please note, this warranty is voided if any fault arises from ill-treatment or careless handling of the product.

## The following are excluded from this warranty :

- A burned voice-coil caused by overloading the loudspeaker.
- Any fault occurring from professional usage (public sound systems, PA systems, etc.)
- Any fault resulting from storage in areas of high humidity.
- Product misuse (too high volume, unsuitable amplifier, etc.)
- A pierced or torn membrane
- A torn suspension
- Any fault resulting from a mechanical shock (ex if dropped or handled roughly)
- Any fault arising from servicing by anyone other than an authorized TRIANGLE service technician
- Damaged cabinets due to mishandling

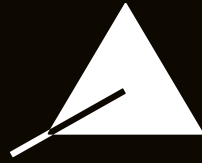

TRIANGLE  
MANUFACTURE ELECTROACOUSTIQUE