

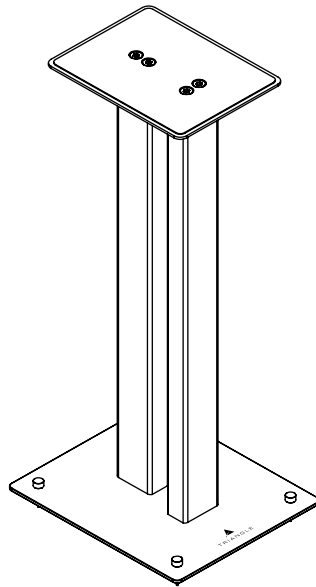

TRIANGLE

MANUFACTURE ELECTROACOUSTIQUE

S02



Notice de montage  
Assembly Guide

---

TRIANGLE DISTRIBUTION FRANCE  
41 rue Borie 33300 Bordeaux  
FRANCE

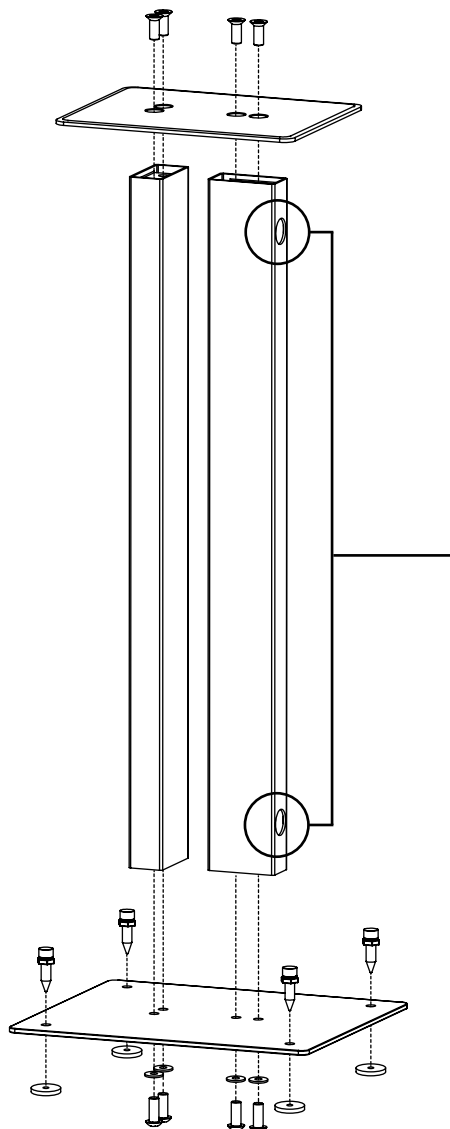

1- Passez les câbles d'enceinte dans les trous dédiés.

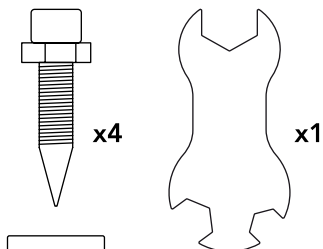

2- Vissez les points de découpage sur la plaque inférieure. Les écrous permettent d'ajuster les pointes en fonction de la planéité de votre sol. Utilisez les contre-pointes dédiées si nécessaire.

Trous pour le passage des câbles.

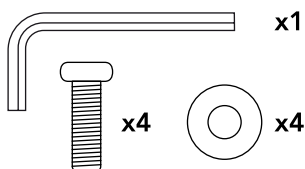

3- Vissez la plaque inférieure aux tubes  
**Attention** : les 2 tubes ne sont pas identiques, veillez à les assembler comme sur le schéma ci-contre.



4- Vissez la plaque supérieure aux tubes.

## ASSEMBLY OF S02 STAND

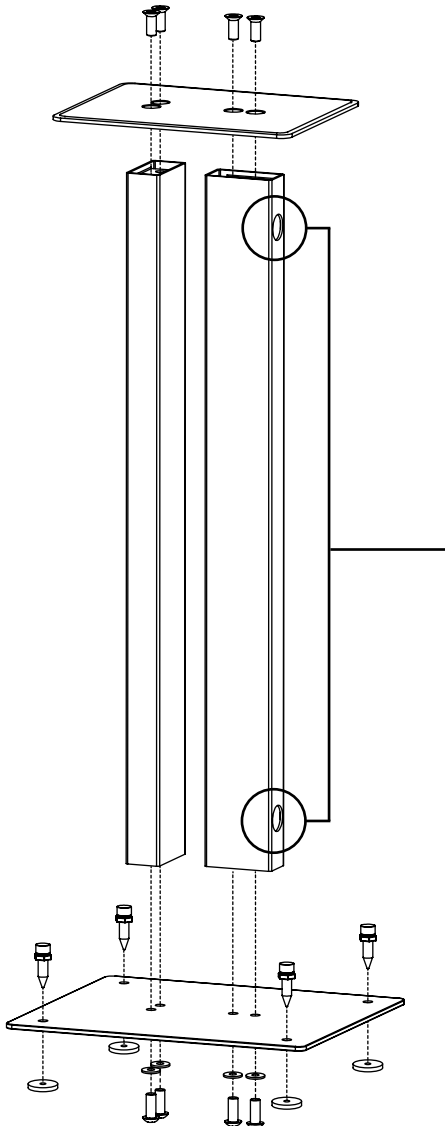

**1-** Route the speaker cables through the dedicated holes.

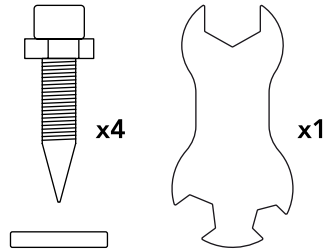

**2-** Attach the spikes on the bottom plate. The provided nuts enable you to adjust the spikes to assure alignment with your floor. Use the dedicated floor protectors if necessary.

Holes for cable management

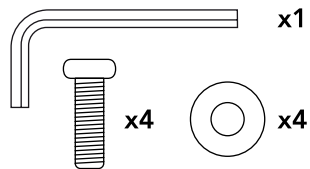

**3-** Fasten the bottom plate to the tubes. **Caution :** the two tubes are not identical, take notion and assemble it exactly as per the schema.



**4-** Secure the top plate to the tubes.



**[www.trianglehifi.com](http://www.trianglehifi.com)**

SITE INTERNET/WEBSITE

**[resellers.trianglehifi.com](http://resellers.trianglehifi.com)**

NOS REVENDEURS/RESELLERS

**[support.trianglehifi.com](http://support.trianglehifi.com)**

SUPPORT & FAQ



[facebook.com/triangle.electroacoustique](https://facebook.com/triangle.electroacoustique)



[twitter.com/trianglehifi](https://twitter.com/trianglehifi)