

KI-115-SMA-II

SINGLE 15" SUBWOOFER



KLIPSCH PROFESSIONAL | PERMANENT INSTALLATION | DATA SHEET



PRODUCT OVERVIEW

Designed for high output and long-term reliability, the Klipsch KI-115-SMA-II low frequency enclosure utilizes a single K-48-ST cast frame 15" woofer. This 104-ounce magnet, 3" voice coil powerhouse delivers high sensitivity with superior power handling. Klipsch's specially designed speaker motor assembly ensures that high transient cone excursions won't damage the voice coil former under extreme output applications.

Perfect for music reinforcement and reproduction, the KI-115 finds ready application in clubs, theaters, auditoriums, churches and performance environments. The rugged, tuned port, 3/4" furniture grade plywood enclosure utilizes CNC fabrication techniques for uniform tolerances, contributing to advanced reliability and ruggedness. Dado "locktab" and rabbet joint construction contribute to freedom from resonance and cabinet-induced coloration.

FEATURES

- High power 15" low frequency speaker system
- Compatible with Klipsch KI-102-SMA-II, KI-172-SMA-II, KI-262-SMA-II, and KI-272-SMA-II speaker models
- Specially designed motor assembly assure high transient cone excursions do not harm the voice coil under extreme out application
- Four suspension points on the back of cabinet (face down orientation only)
- 124 dB SPL maximum output
- Available in Black, White or Raw Birch finish

APPLICATIONS

- Performing Spaces
- Auditoriums and Houses of Worship
- Bars and Music Clubs
- Small/medium Sports Facilities
- Theme Parks and Leisure Venues

DESIGNED AND MADE IN THE USA

USING DOMESTIC AND IMPORTED COMPONENTS

In 1946, Paul W Klipsch, genius & maverick, hand-built his first loudspeaker in a tin shed with the intention of bringing live music into his living room. Remember great sound? We do, too. Today, Klipsch's KI series speaker enclosures are made in the USA, by proud craftsmen in Hope, Arkansas. Just like PWK intended.

SPECIFICATIONS

FREQUENCY RESPONSE¹ (+/- 3 dB)	49 Hz - 200 kHz (-10 dB @ 35 Hz)
POWER HANDLING²	400 watts (44.7V) 1600 watts peak
MAXIMUM SPL³	124 dB Continuous 130 dB Peak
SENSITIVITY⁴	101 dB
NOMINAL IMPEDANCE	8 ohms, minimum 5 ohms @ 39 Hz
COMPONENTS	One K-48-ST 15" woofers
INPUT CONNECTION	Two point barrier strip
MOUNTING OPTIONS	Four 3/8"-16 flypoints
ENCLOSURE MATERIAL	3/4" 7-ply birch plywood cabinet
HEIGHT	18.5" (46.99cm)
WIDTH	24.6" (62.48cm)
DEPTH	19.2" (48.77cm)
WEIGHT	62 lbs. (28.18kg)
FINISHES	Black, White and Raw Birch finish

¹ 3M, Half-spaced anechoic

² AES standard, continuous pink noise, 6 dB peaks

³ Calculated at 1M half-spaced at power handling power input

⁴ SPL at 1M, half-spaced anechoic with 2.83V input

KI-115-SMA-II

SINGLE 15" SUBWOOFER



KLIPSCH PROFESSIONAL | PERMANENT INSTALLATION | DATA SHEET

FREQUENCY RESPONSE

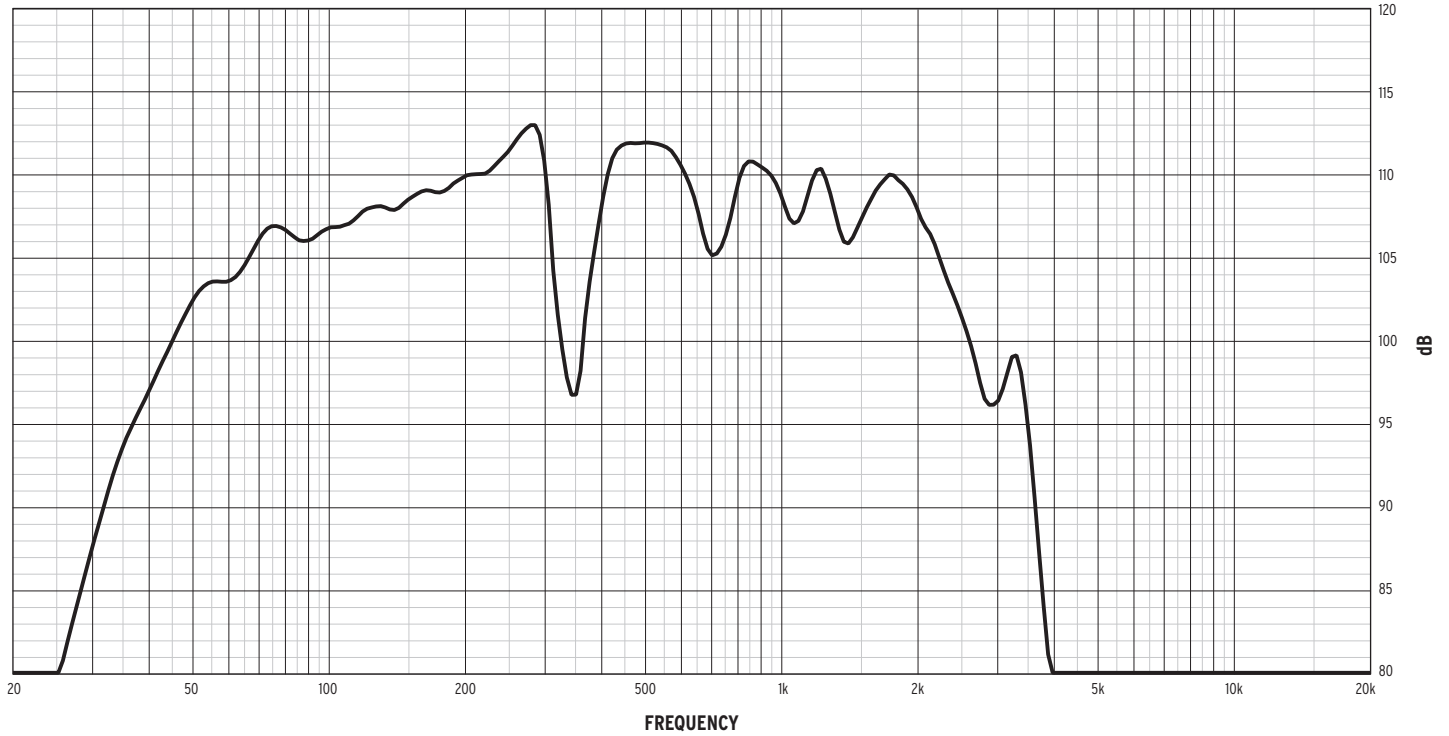

IMPEDANCE

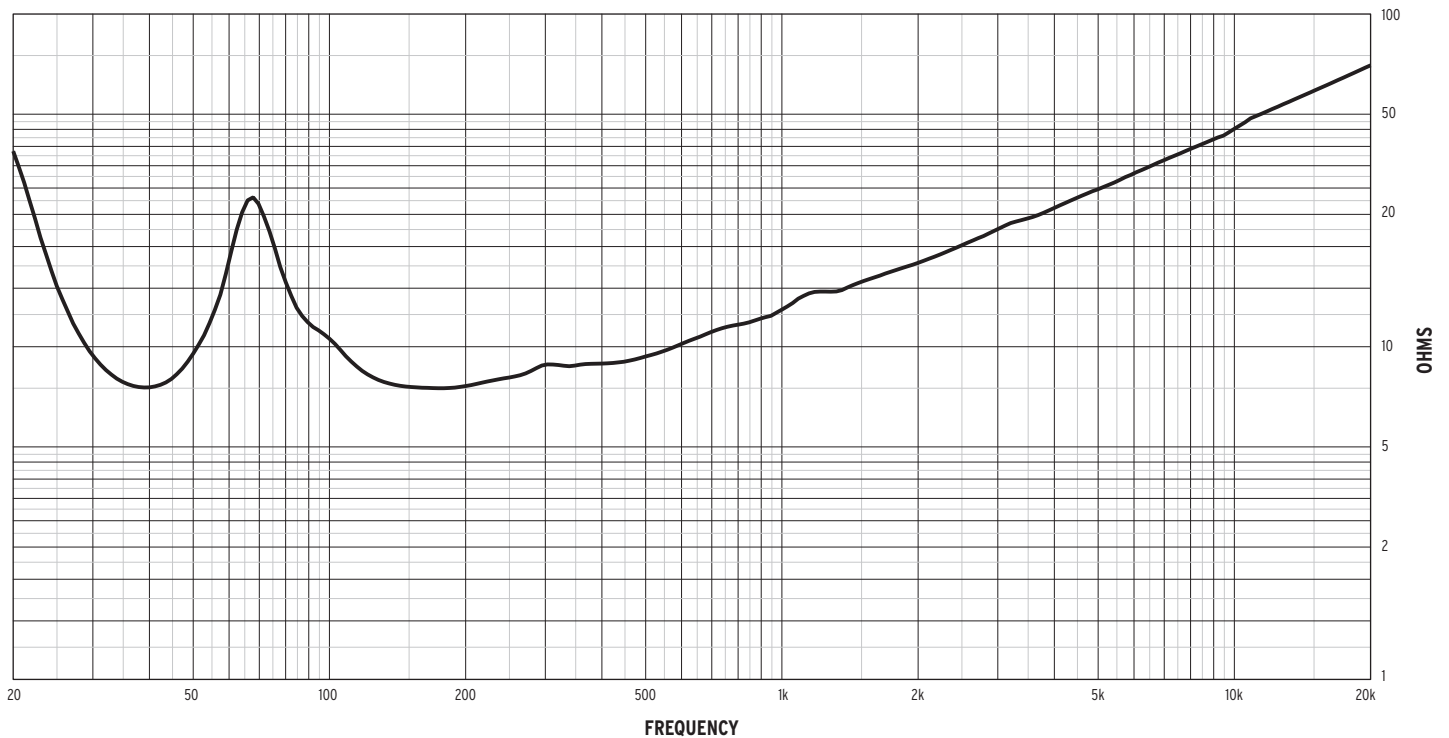

KI-115-SMA-II

SINGLE 15" SUBWOOFER



KLIPSCH PROFESSIONAL | PERMANENT INSTALLATION | DATA SHEET

HORIZONTAL OFF AXIS TRANSFER FUNCTION

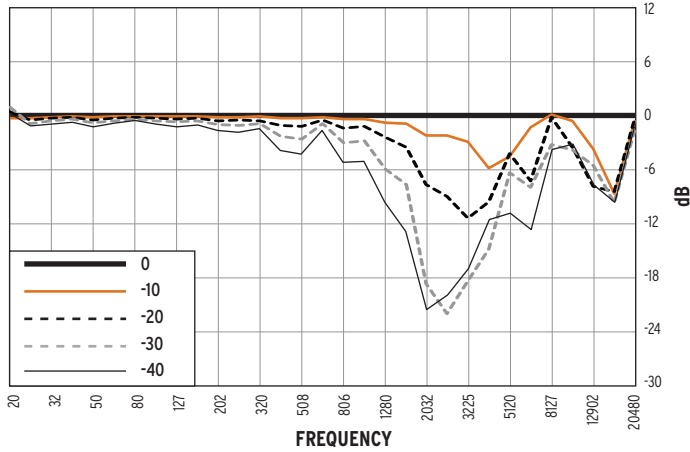

HORIZONTAL COVERAGE (-6dB)

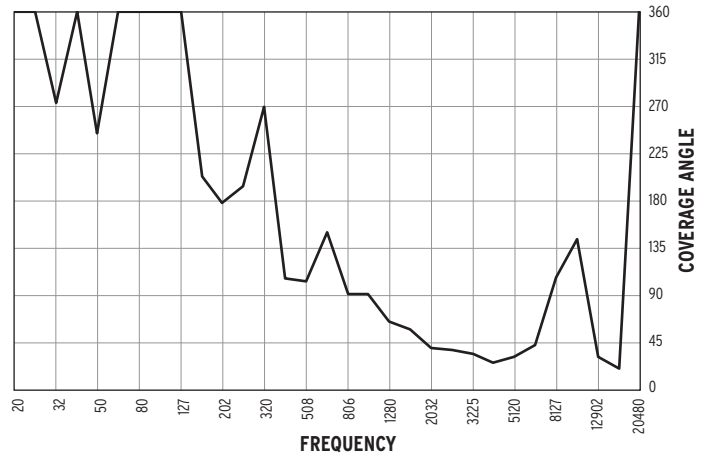

VERTICAL OFF AXIS TRANSFER FUNCTION

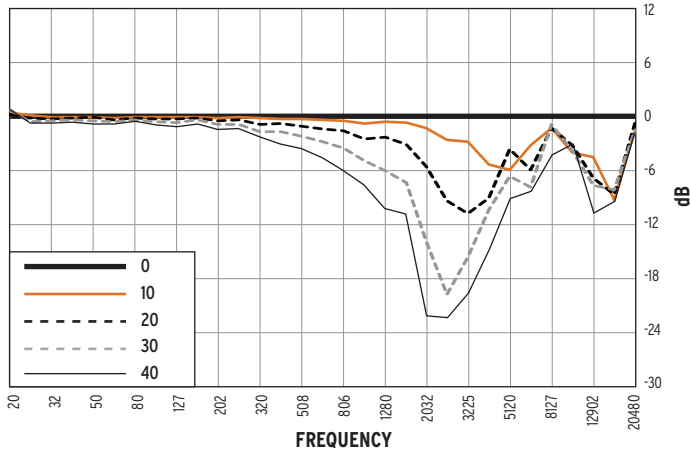

VERTICAL COVERAGE (-6dB)

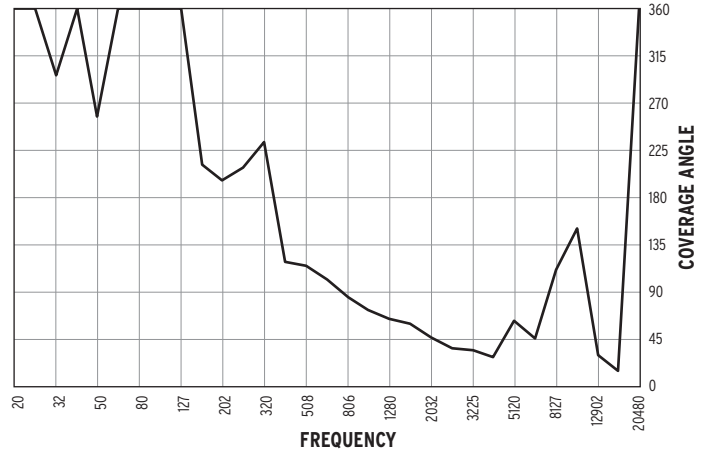

DIRECTIVITY INDEX

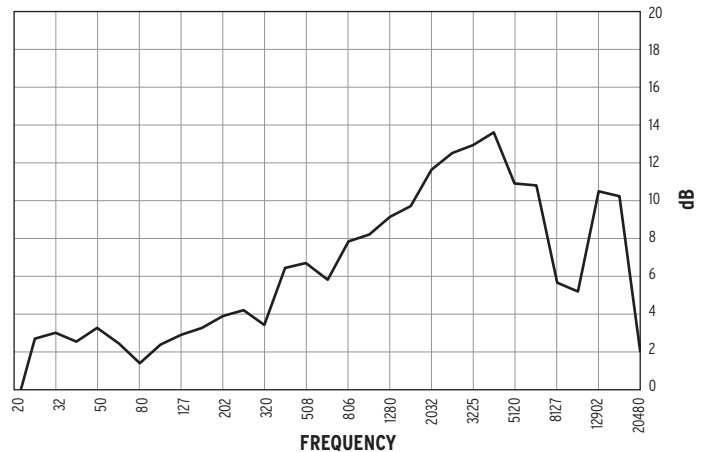

KI-115-SMA-II

SINGLE 15" SUBWOOFER



KLIPSCH PROFESSIONAL | PERMANENT INSTALLATION | DATA SHEET

HORIZONTAL 1/3 OCTAVE POLARS

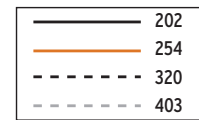
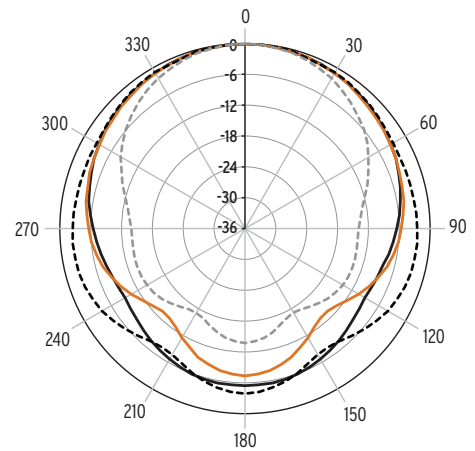
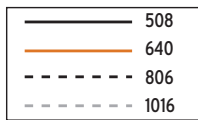
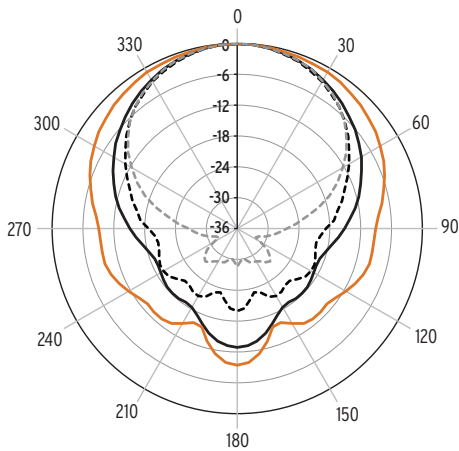
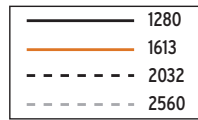
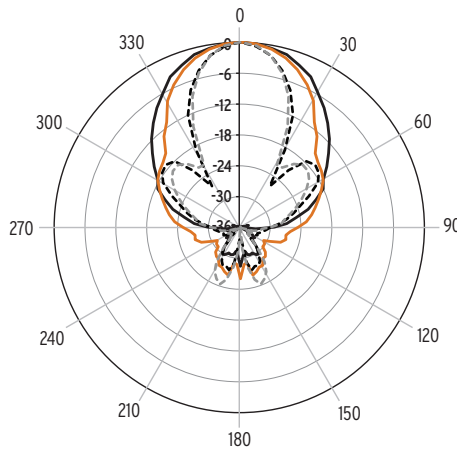

KI-115-SMA-II

SINGLE 15" SUBWOOFER



KLIPSCH PROFESSIONAL | PERMANENT INSTALLATION | DATA SHEET

VERTICAL 1/3 OCTAVE POLARS

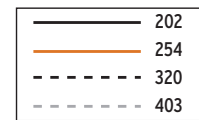
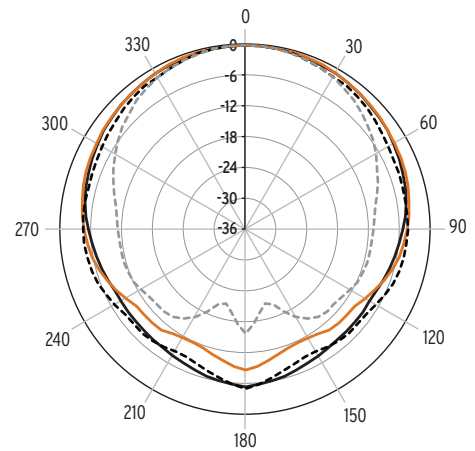
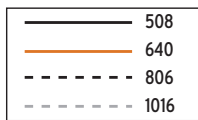
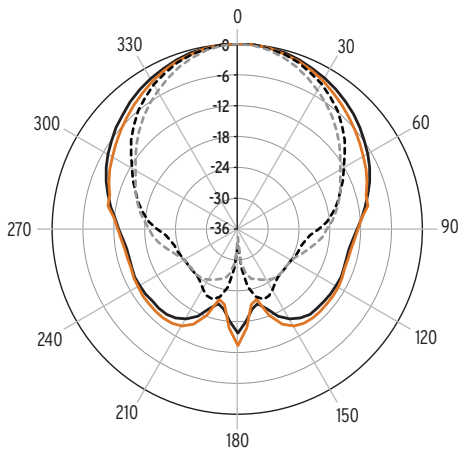
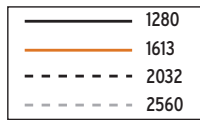
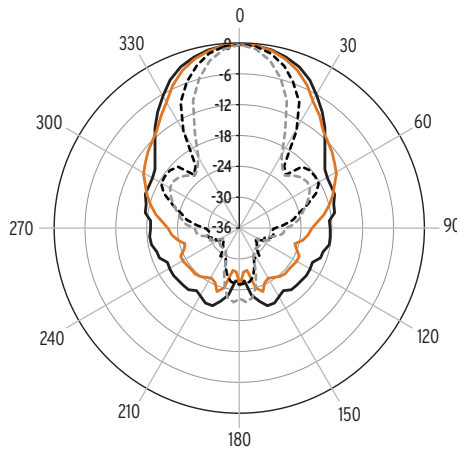

KI-115-SMA-II

SINGLE 15" SUBWOOFER



KLIPSCH PROFESSIONAL | PERMANENT INSTALLATION | DATA SHEET

ARCHITECTURAL SPECIFICATIONS

The KI-115-SMA-II professional subwoofer shall include a 15" (381mm) K-45-ST low-frequency transducer utilizing 3" (76.2mm) voice coil, and 104-ounce (2.95kg) motor magnet assembly. The enclosure tuning shall be of a vented design.

Frequency response shall be 49Hz to 200Hz, +/- 3dB, with the -10dB point at 35Hz, measured at three meters, half-space anechoic. Sensitivity shall be 101dB SPL, measured at one meter, half space anechoic, with a 2.83v input. Power handling shall be 400 watts (44.7volts), to AES standards, continuous pink noise, 40Hz to 400Hz, 6db peaks. Calculated maximum continuous output at one meter shall be 124dB SPL. Nominal impedance shall be 8 ohms, with 5 ohms minimum at 39Hz.

Signal connections shall be made via a two-point barrier strip. The enclosure panels shall be CNC-fabricated, 3/4" 7-ply birch plywood, assembled using rabbet and dado joinery. Dimensions for the enclosure shall be 18.5" (46.99 cm) high by 19.2" (48.77cm) deep by 24.6" (62.48cm) wide, in a rectangular shape. Net weight shall be 62lbs. (28.18kg). The enclosure will have a metal perforated grille for structural integrity and protection of the transducers from impact and tampering. Enclosure flying capability shall be provided via four, on back panel, internal 3/8" 16-thread mounting points.

The enclosure shall be coated with lacquer-based primer and lacquer-based texture, with a black or white finish. The enclosure shall also be available unfinished in raw birch.

The system shall be a Klipsch KI-115-SMA-II loudspeaker.

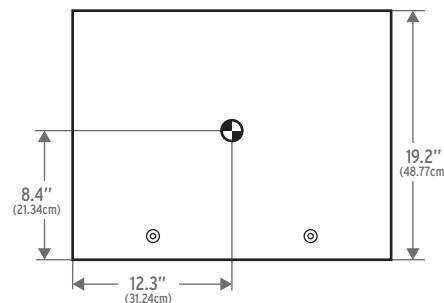

TOP/BOTTOM

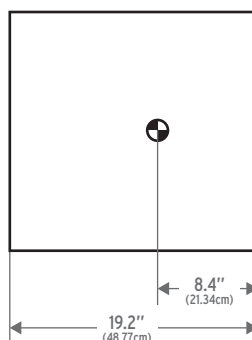

SIDE

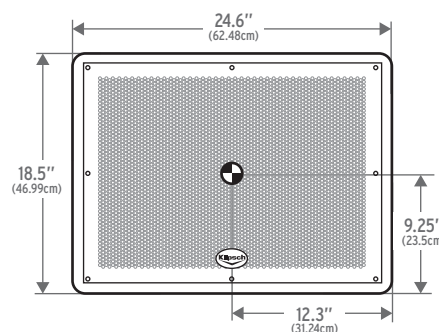

FRONT

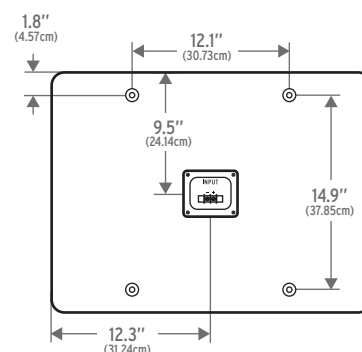
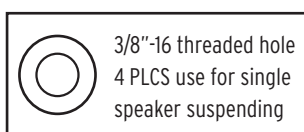

BACK

NEED HELP WITH YOUR PRO SYSTEM DESIGN?

You need to make the best impression, from the initial job quote through the completed installation. We can help choose the best Klipsch speakers for the application and help design a system that unleashes your venue's full potential.

Send us your plans or questions to us at:

PROSYSTEMDESIGN@KLIPSCH.COM



KI-115-SMA-II

SINGLE 15" SUBWOOFER



KLIPSCH PROFESSIONAL | PERMANENT INSTALLATION | DATA SHEET

ORDERING INFORMATION

KI-115-SMA-II

PART NUMBER	MODEL NAME	FINISH	PACKED QUANTITY	DESCRIPTION	UPC
1062011	KI-115-B-SMA-II	Black	1	Standard 8 ohm speaker	743878027952
1062012	KI-115-W-SMA-II	White	1	Standard 8 ohm speaker	743878029178
1062013	KI-115-R-SMA-II	Raw Birch	1	Standard 8 ohm speaker	743878029161

KI-115-SMA-II CARTON DIMENSIONS

HEIGHT	22" (55.9cm)
WIDTH	26.8" (68.1cm)
DEPTH	20.9" (53.1cm)